

# User Guide

**INSIGNIA™**

26"/32" LCD, 1080p

**NS-26L450A11/NS-32L450A11**



## Contents

---

CHILD SAFETY .....	1
Important safety instructions .....	2
Warnings .....	2
Cautions .....	3
Introduction .....	4
Install the stand or wall-mount bracket .....	5
Installing the stand .....	5
Installing a wall-mount bracket .....	5
TV components .....	6
Accessories .....	6
Front .....	6
TV control buttons .....	6
Side jacks .....	7
Back .....	7
Remote control .....	8
Using the remote control .....	9
Installing remote control batteries .....	9
Aiming the remote control .....	9
Using the remote control holder .....	10
Programming your universal Insignia remote control .....	10
Programming a universal remote control to work with your TV .....	13
Making connections .....	14
Connecting power .....	14
Connecting an antenna or cable TV without a cable box .....	14
Connecting a cable or satellite box .....	14
Connecting an HDMI device .....	15
Connecting a DVI device .....	16
Connecting a component video device .....	16
Connecting an S-Video device .....	17
Connecting a VCR .....	17
Connecting a camcorder or game console .....	18
Connecting a computer .....	18
Connecting a USB device .....	19
Connecting headphones .....	19
Connecting a digital sound system .....	19
Connecting an analog sound system .....	20
Turning on your TV for the first time .....	20
Understanding the basics .....	21
Turning your TV on or off .....	21
Selecting the video input source .....	21
On-screen menu overview .....	22
Navigating the menus .....	22
Selecting a channel .....	23
Adjusting the volume .....	23
Displaying additional information .....	23

- Adjusting the picture .....23
  - Adjusting the TV picture .....23
  - Adjusting the computer image .....24
- Adjusting the sound .....25
  - Adjusting sound settings .....25
  - Selecting the audio mode .....25
  - Playing TV audio only .....26
- Changing channel settings .....26
  - Automatically scanning for channels .....26
  - Hiding channels .....27
  - Setting up a favorite channel list .....27
  - Viewing a favorite channel .....28
  - Adding or changing a channel label .....28
  - Checking the digital signal strength .....29
- Setting parental controls .....29
  - Setting or changing the password .....29
  - Locking control buttons .....30
  - Blocking unrated TV .....31
  - Setting parental control levels .....31
  - Downloading rating information .....33
- Using closed captioning .....33
  - Turning closed captioning on or off .....33
  - Selecting the analog closed captioning mode .....34
  - Customizing digital closed captioning styles .....34
- Adjusting time settings .....35
  - Setting the time .....35
  - Setting the sleep timer .....36
- Adjusting menu settings .....37
  - Selecting the menu language and transparency .....37
  - Labeling an input source .....37
  - Turning Auto Input Sensor on or off .....38
  - Using INlink .....38
  - Restoring settings to the defaults .....40
- Using USB .....40
  - Switching to USB mode .....41
  - Browsing photos .....41
  - Viewing favorite photos .....41
  - Viewing photos in a slideshow .....42
  - Customizing slideshow settings .....42
- Maintaining .....43
  - Cleaning the TV cabinet .....43
  - Cleaning the LCD screen .....43
- Troubleshooting .....43
- Specifications .....44
- Manufacturers' codes .....45
- Legal notices .....57
- Two-year limited warranty .....61
  - US and Canada Markets .....61
  - Mexico Market .....61



## CHILD SAFETY

**It makes a difference how and where you use your flat panel display**

**As you enjoy your new product, keep these safety tips in mind**

### *The issue*

The home theater entertainment experience is a growing trend, and larger TVs are popular purchases. However, TVs are not always supported on the proper stands or installed according to the manufacturer's recommendations. We and the consumer electronics industry are committed to making home entertainment enjoyable and safe.

*TVs that are inappropriately placed on dressers, bookcases, shelves, desks, speakers, chests, or carts may fall over and cause injury.*

### *Tune into safety*

- One size of TV stand does **not** fit all. Use only a TV stand rated for the weight of your TV.
- Carefully read and understand all enclosed instructions for proper use of this product.
- Don't let children climb on or play with entertainment system furniture and TVs.
- Don't place TVs on furniture that can easily be used as steps, such as a crate or chest of drawers.
- Remember that children can become excited while watching a program, especially on a "larger-than-life" TV. Make sure that you place or install the TV where it cannot be pushed, pulled over, or knocked down.
- Make sure that you route all cords and cables so that they cannot be pulled or grabbed by curious children.



### *Wall mounting*

If you decide to wall mount your TV, always remember:

- One size of wall mount does **not** fit all. Use only a wall mount rated for the weight of your TV and that has been recommended by this TV manufacturer, listed in this manual, or otherwise listed by an independent laboratory as suitable for your TV.
- Follow all instructions supplied by the TV and wall mount manufacturers.
- If you have any doubts about your ability to safely wall mount your TV, get help from a professional installer.
- Make sure that the wall where you are mounting the TV is appropriate. Some wall mounts are not designed to be mounted to walls backed with steel studs or cinder blocks. If you are unsure, ask a professional installer.
- TVs can be heavy. At least two people are required for safe wall mount installation.



## Important safety instructions



This symbol indicates that dangerous voltage constituting a risk of electric shock is present within your TV. This label is located on the back of your TV.



This symbol indicates that there are important operating and maintenance instructions in the literature accompanying your TV.

- 1 Read these instructions.
- 2 Keep these instructions.
- 3 Heed all warnings.
- 4 Follow all instructions.
- 5 Do not use this apparatus near water.
- 6 Clean only with a dry cloth.
- 7 Do not block any ventilation openings. Install in accordance with the manufacturer's instructions.
- 8 Do not install near any heat sources such as radiators, heat registers, stoves, or other apparatus (including amplifiers) that produce heat.
- 9 Do not defeat the safety purpose of the polarized or grounding-type plug. A polarized plug has two blades with one wider than the other. A grounding type plug has two blades and a third grounding prong. The wide blade or the third prong are provided for your safety. If the provided plug does not fit into your outlet, consult an electrician for replacement of the obsolete outlet.
- 10 Protect the power cord from being walked on or pinched particularly at plugs, convenience receptacles, and the point where they exit from the apparatus.
- 11 Only use attachments/accessories specified by the manufacturer.
- 12 Use only with a cart, stand, tripod, bracket, or table specified by the manufacturer, or sold with the apparatus. When a cart is used, use caution when moving the cart/apparatus combination to avoid injury from tip-over.  S3125A
- 13 Unplug this apparatus during lightning storms or when unused for long periods of time.
- 14 Refer all servicing to qualified service personnel. Servicing is required when the apparatus has been damaged in any way, such as power-supply cord or plug is damaged, liquid has been spilled or objects have fallen into the apparatus, the apparatus has been exposed to rain or moisture, does not operate normally, or has been dropped.

- 15 The *wall plug* is the disconnecting device. The plug must remain readily operable.
- 16 An apparatus with three-prong, grounding-type plug is a Class I apparatus. Class I apparatus which needs to be grounded to prevent possible electric shock. Make sure that you connect the Class I apparatus to a grounding-type, three-prong outlet.
- 17 Remote control batteries should not be exposed to excessive heat such as sunshine, fire, or the like.
- 18 The apparatus should not be exposed to dripping or splashing, and no objects filled with liquids, such as vases, should be placed on the apparatus.

### Warnings

#### Electric shock hazard

To reduce the risk of fire or electric shock, do not remove any cover or expose the device to rain or moisture. No user-serviceable parts are inside. Refer servicing to qualified service technicians.

#### Lightning

For added protection for your device receiver during a lightning storm, or when it is left unattended and unused for long periods of time, unplug it from the power outlet and disconnect any antenna or cable system. This helps prevent property damage and personal injury from lightning and power line surges.

#### Power lines

An outside antenna system should not be located in the vicinity of overhead power lines or other electric light or power circuits, or where it can fall into such power lines or circuits. When installing an outside antenna system, extreme care should be taken to keep from touching such power lines or circuits as contact with them might be fatal.

#### Handling the LCD panel

- Your TV's screen is made of glass. Do not drop your TV or hit, jolt, or press hard against the LCD panel. If the screen breaks, be careful of broken glass.
- If the LCD panel is broken, make absolutely sure that you do not touch the liquid in the panel. This may cause skin inflammation.
- If the liquid gets in your mouth, immediately gargle, rinse, and consult with your doctor. Also, if the liquid gets in your eyes or touches your skin, consult with your doctor after rinsing for at least 15 minutes or longer in clean water.

#### Replacement parts

When replacement parts are required, make sure that the service technician uses replacement parts specified by the manufacturer that have the same characteristics as the original part. Unauthorized substitutions may result in fire, electric shock, personal injury, or other hazards.

#### Safety check

After completing any service or repair to this device, ask the service technician to perform routine safety checks to determine that your TV is in correct operating condition.

## Power source

Operate your TV only from the type of power source indicated on the marking label. If you are not sure of the type of power supplied to your home, consult an electrician or your local power company.

## Cautions

### Damage requiring service

- Unplug this TV from the power outlet and refer servicing to qualified service personnel under the following conditions:
- When the power supply cord or plug is damaged or frayed.
  - If liquid has been spilled or objects have fallen into your TV.
  - If your TV has been exposed to rain or water.
  - If your TV does not operate normally by following the operating instructions. Adjust only those controls that are covered by the operating instructions because incorrect adjustment of other controls may result in damage and will often require extensive work by a qualified technician to restore your TV to its normal operation.
  - If your TV has been dropped or damaged in any way.
  - When your TV exhibits a distinct change in performance.

### Outdoor antenna grounding

If an outside antenna or cable system is connected to your TV, make sure that the antenna or cable system is grounded to provide some protection against voltage surges and built-up static charges. Article 810 of the National Electrical Code, ANSI/NFPA No. 70, provides information with respect to correct grounding of the mast and supporting structure, grounding of the lead-in wire to an antenna discharge unit, size of grounding conductors, location of the antenna-discharge unit, connection to grounding electrodes, and requirements for the grounding electrode.

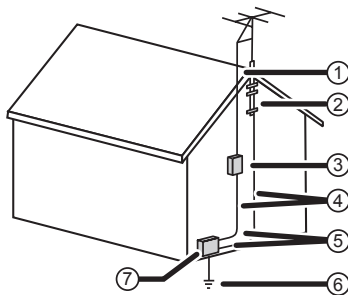

- ① Antenna lead-in wire
- ② Grounding clamp
- ③ Antenna discharge unit
- ④ Grounding conductors
- ⑤ Ground clamps
- ⑥ Power service grounding electrode system
- ⑦ Electric service equipment

## Note to CATV system installer

Article 820 of the National Electrical Code, ANSI/NFPA No. 40 provides guidance for correct grounding. Specifically, it states that the cable ground must be connected to the grounding system of the building as close to the point of cable entry as practical.

## Condensation

Moisture will form on the TV if the TV is brought from cool surroundings into a warm room or if the temperature of the room rises suddenly. When this happens, the TV's performance may be impaired. To prevent this, let the TV stand in its new surroundings for about an hour before switching it on, or make sure that the room temperature rises gradually. Condensation may also form during the summer if the TV is exposed to the breeze from an air conditioner. In such cases, change the location of the TV.

## Mobile telephone warning

To avoid interference with your TV picture and sound, operating problems, or even damage, keep your cordless and cellular telephones away from the TV.

## End of life directives

Your TV contains tin-lead solder and a fluorescent lamp containing a small amount of mercury. Disposal of these materials may be regulated for environmental reasons. Your TV also contains material that can be recycled and reused. For disposal or recycling information, contact your local authorities or the Electronic Industries Alliance at [www.eia.org](http://www.eia.org) to find a recycler in your area.

## Non-active pixels

The LCD panel contains almost 3 million thin film transistors, which provide exceptionally sharp video quality. Occasionally, a few non-active pixels may appear on the screen as a fixed blue, green, or red point. These non-active pixels do not adversely affect the performance of your TV, and are not considered defects.

---

# 26"/32" LCD, 1080p

---

## Introduction

Congratulations on your purchase of a high-quality Insignia product. Your NS-26L450A11 or NS-32L450A11 represents the state of the art in LCD TV design and is designed for reliable and trouble-free performance.

### **AUDYSSEY Dynamic Volume plus Dynamic EQ:**

Have you ever caught yourself wishing that you didn't constantly need to adjust the volume: wishing that the commercials wouldn't blare and that you could better hear whispering during a movie scene? Audyssey Dynamic Volume is a feature that lets you put the remote control down and enjoy your show while Audyssey adjusts the sound levels for you automatically. Audyssey Dynamic EQ is a feature that automatically finds the richest sound settings-including enhanced bass-for each scene, even when the volume level is held steady, making the sound coming from your TV speakers sound more lifelike. See page 25 for instructions on how to adjust the audio settings to take advantage of Audyssey.

### **SRS TruSurround HD:**

At Insignia, providing you with superior audio quality is just as important as exceptional picture quality. That's why we added SRS TruSurround HD, which provides you with a theater-like surround-sound experience, with the clearer dialog and the enhanced bass sounds that movie viewers and gamers crave.

### **INlink:**

Enjoy the benefit of having HDMI CEC compatible products plug and play! No setup is needed! CEC technology lets different components discover and communicate with each other. (See page 38 for instructions on how to use INlink)



# Install the stand or wall-mount bracket

To set your TV on a cabinet or other flat surface, you must install the stand.

To mount your TV on a wall or other vertical surface, you must remove the stand.

## Warning

Make sure that you unplug the AC power cord before you install or remove the stand.

## Cautions

Read these instructions carefully before you try to install the stand or a wall-mount bracket. If you are not sure you can install the stand or wall-mount bracket, consult a professional installer or service personnel. Your warranty does not cover damages or injuries that happen due to mishandling or incorrect assembly. When installing the stand or wall-mount bracket, make sure that you place your TV on a soft cushion or covering to prevent scratching or damage to your TV's finish or screen.

## Installing the stand

### To install the stand:

- 1 Carefully place your TV screen face-down on a cushioned, clean surface to protect the screen from damages and scratches.
- 2 Align the stand on the TV base, then insert the metal tabs on the stand into the designated slots on the TV base.

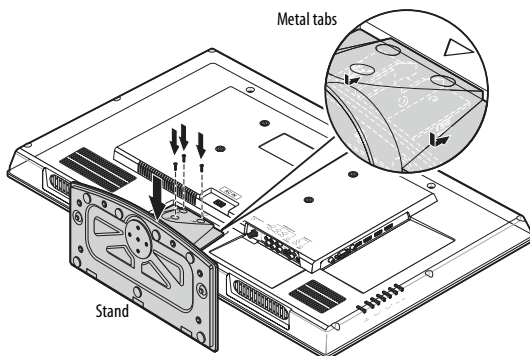

- 3 Secure the stand with the three M4 × L14 mm screws (provided).

## Installing a wall-mount bracket

### To attach your TV to a wall-mount bracket:

- 1 Carefully place your TV screen face-down on a cushioned, clean surface to protect the screen from damages and scratches.
- 2 Remove the three screws holding the TV to its stand, then remove the stand.

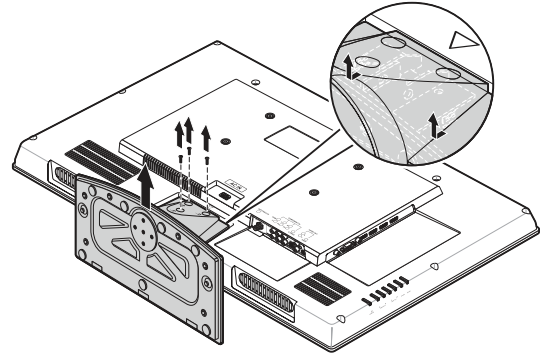

- 3 Secure the wall mount bracket to the back of your TV using the four screws provided with the bracket.

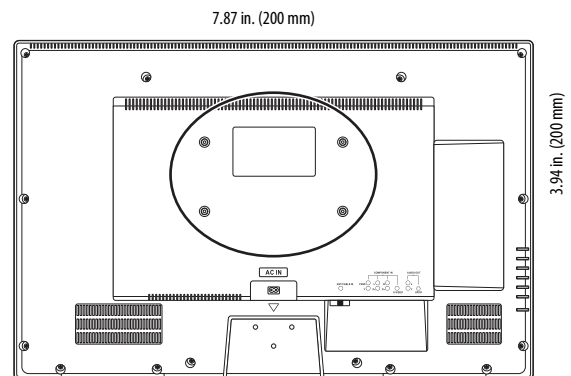

## TV components

### Accessories

- AC power cord
- TV stand with screws
- Remote control with AA batteries (2)
- Remote control holder
- Component cable
- Audio cable
- Cleaning cloth
- *Quick Setup Guide*

### Front

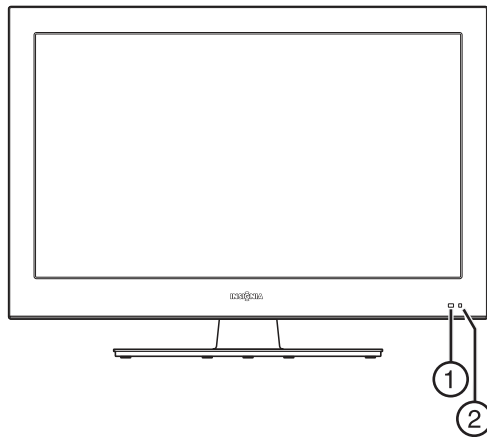

#	Item	Description
①	Remote control sensor	Receives signals from the remote control. Do not block.
②	Power indicator	Lights blue color when your TV is turned on. Lights red when your TV is in Standby mode.

### TV control buttons

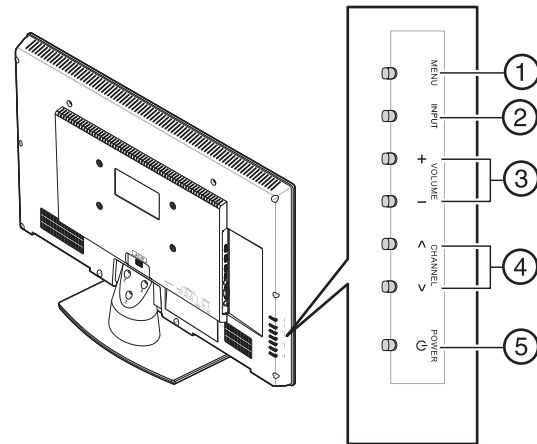

#	Item	Description
①	MENU	Press to open the on-screen menu.
②	INPUT	Press to select the video input source. For more information, see "Selecting the video input source" on page 21
③	VOLUME+/-	Press to increase or decrease the volume.
④	CHANNEL ^ / v	Press to change TV channels. For more information, see "Selecting a channel" on page 23.
⑤	POWER 	Press to turn on your TV. Press again to put your TV in standby mode. When your TV is in standby mode, power still flows through it. To completely disconnect power, unplug the power cord.

**Side jacks**

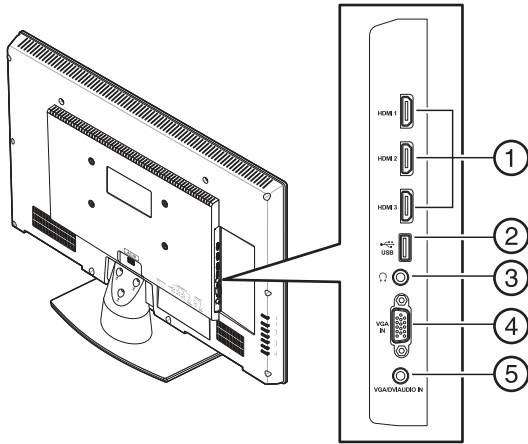

#	Item	Description
①	HDMI 1/HDMI 2/HDMI 3	Connect HDMI devices to these jacks. An HDMI cable carries both video and sound. You do not need to make an audio connection for an HDMI device. For more information, see "Connecting an HDMI device" on page 15.
②	USB	Connect a USB flash drive to this jack to view JPEG photos on your TV. For more information, see "Connecting a USB device" on page 19.
③	🎧 (headphones)	Connect headphones to this jack. For more information, see "Connecting headphones" on page 19.
④	VGA IN	Connect the video for a computer to this jack. For more information, see "Connecting a computer" on page 18.
⑤	VGA/DVI AUDIO IN	Connect the audio for a computer or DVI device to the this jack. For more information, see "Connecting a computer" on page 18 or "Connecting a DVI device" on page 16.

**Back**

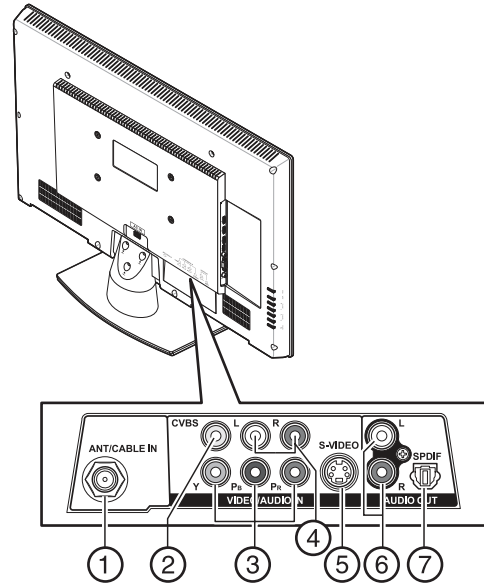

#	Item	Description
①	ANT/CABLE IN	Connect an antenna, cable TV, or satellite TV box to this jack. For more information, see "Connecting an antenna or cable TV without a cable box" on page 14.
②	CVBS (composite video)	Connect the video for a composite video device to this jack. For more information, see "Connecting a camcorder or game console" on page 18.
③	Y/Pb/Pr (component video)	Connect the video for a component video device to these jacks. For more information, see "Connecting a component video device" on page 16.
④	L/R (audio in)	Connect the audio for a composite video device connected to the CVBS jack, for a component video device connected to the Y/Pb/Pr jacks or an S-VIDEO device connected to the S-VIDEO jack. For more information, see "Connecting a camcorder or game console" on page 17, "Connecting a component video device" on page 16, or "Connecting an S-Video device" on page 17.
⑤	S-VIDEO	Connect the video for an S-Video device to this jack. For more information, see "Connecting an S-Video device" on page 17.
⑥	L/R (audio out)	Connect an analog sound system to these jacks. See "Connecting an analog sound system" on page 20.
⑦	SPDIF	Connect a digital sound system to this jack to send the TV audio through the sound system. For more information, see "Connecting a digital sound system" on page 19.

## Remote control

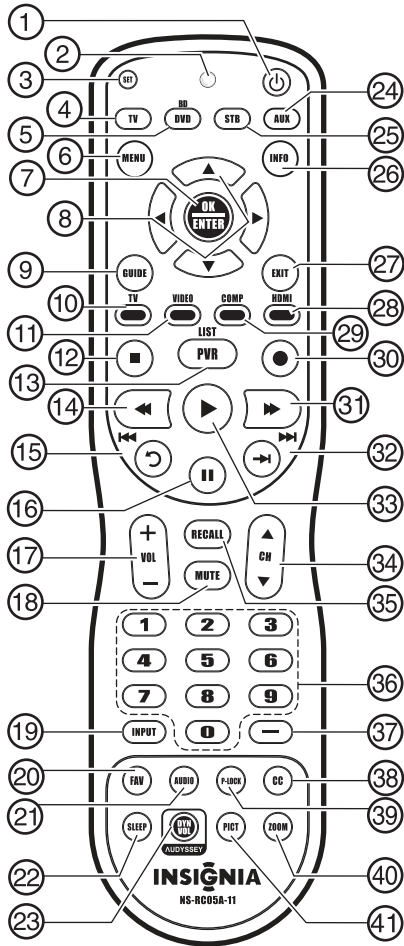

#	Item	Description
1	Power	Press to turn your TV on or off (Standby mode). When your TV is off, power still flows into it. To disconnect power, unplug the power cord.
2	Remote control indicator	Lights when you press a button on the remote control.
3	SET	Press to program the remote control to control connected devices. For more information, see "Programming your universal Insignia remote control" on page 10.
4	TV	Press to control your TV.
5	BD/DVD	Press to control a connected Blu-ray or DVD player. You must program the remote control before this button works. For more information, see "Programming your universal Insignia remote control" on page 10.
6	MENU	Press to open the on-screen menu.
7	OK/ENTER	Press to confirm selections or changes.
8	Navigation arrows	Press to move left, right, up, or down in on-screen menus.
9	GUIDE	Press to display the program guide. For more information, see "Displaying additional information" on page 23.
10	TV	Press to select TV as the video source.
11	VIDEO	Press to select the device connected to the CVBS or S-VIDEO jack.

#	Item	Description
12	Stop	Press to stop playback on DVD, DVR, PVR, or CD devices. You need to program the remote control to control connected devices. For more information, see "Programming your universal Insignia remote control" on page 10.
13	PVR/LIST	Press to list all the recorded programs in a PVR/STB. You need to program the remote control to control connected devices. For more information, see "Programming your universal Insignia remote control" on page 10.
14	Fast reverse	Press to fast reverse on DVD, DVR, PVR, or CD devices. You need to program the remote control to control connected devices. For more information, see "Programming your universal Insignia remote control" on page 10.
15	Skip back	In DVD, DVR, PVR, or CD mode, press to skip back to the previous title or track. You need to program the remote control to control connected devices. For more information, see "Programming your universal Insignia remote control" on page 10.
16	Pause	In DVR mode, the behavior of this button depends on how you programmed your remote control. Press to pause playback on DVD, DVR, PVR, or CD devices. You need to program the remote control to control connected devices. For more information, see "Programming your universal Insignia remote control" on page 10.
17	VOL+/VOL-	Press to increase or decrease the volume.
18	MUTE	Press to mute the sound. Press again to restore the sound.
19	INPUT	Press to open the Source List, then press ▲ or ▼ to cycle through the available input sources. For more information, see "Selecting the video input source" on page 21.
20	FAV	Press to open the Favorite Channel list. For more information, see "Setting up a favorite channel list" on page 27.
21	AUDIO	Press to select <b>Bass</b> or <b>Treble</b> . For more information, see "Adjusting sound settings" on page 25.
22	SLEEP	Press to set the sleep timer. You can select <b>Off</b> , <b>5</b> , <b>10</b> , <b>15</b> , <b>30</b> , <b>60</b> , <b>90</b> , <b>120</b> , <b>180</b> , or <b>240</b> minutes. For more information, see "Setting the sleep timer" on page 36.
23	DYN VOL	Press to select the level of Audyssey Dynamic Volume. You can select <b>Heavy</b> , <b>Medium</b> , <b>Light</b> , or <b>Off</b> . For information see "Adjusting sound settings" on page 25.
24	AUX	Press to control a connected device. You need to program the remote control to control connected devices. For more information, see "Programming your universal Insignia remote control" on page 10.
25	STB	Press to control a connected set-top box. You need to program the remote control to control connected devices. For more information, see "Programming your universal Insignia remote control" on page 10.
26	INFO	Press to display TV status information, such as the channel number, channel name (if available), or signal source. For more information, see "Displaying additional information" on page 23.
27	EXIT	Press to close the on-screen menu.
28	HDMI	Press one or more times to select the device connected to the <b>HDMI 1</b> , <b>HDMI 2</b> , or <b>HDMI 3</b> jack.
29	COMP	Press to select the device connected to the <b>Y/Pb/Pr</b> (component video) jacks.
30	Record	In DVD, DVR, PVR, or CD mode, press to begin recording. You need to program the remote control to control connected devices. For more information, see "Programming your universal Insignia remote control" on page 10.

#	Item	Description
31	▶▶ (fast forward)	Press to fast forward on DVD, DVR, PVR, or CD devices. You need to program the remote control to control connected devices. For more information, see "Programming your universal Insignia remote control" on page 10. In DVR mode, the behavior of this button depends on how you programmed your remote control.
32	▶▶/▶ (skip forward)	In DVD, DVR, PVR, or CD mode, press to skip forward to the next title or track. You need to program the remote control to control connected devices. For more information, see "Programming your universal Insignia remote control" on page 10. In DVR mode, the behavior of this button depends on how you programmed your remote control.
33	▶ (play)	Press to start playback on DVD, DVR, PVR, or CD devices. You need to program the remote control to control connected devices. For more information, see "Programming your universal Insignia remote control" on page 10.
34	CH ▲/CH ▼	Press to change TV channels. For more information, see "Selecting a channel" on page 23.
35	RECALL	In TV mode, press to return to the previous channel.
36	Numbers	Press to enter channel numbers and the parental control password. When programming the remote control, press to enter device and programming codes.
37	—	Press to enter a digital sub-channel number. For more information, see "Selecting a channel" on page 23.
38	CC	Press to turn closed captioning on or off. You can select <b>CC Off</b> , <b>CC On</b> , or <b>CC On when Mute</b> . For more information, see "Turning closed captioning on or off" on page 33.
39	P-LOCK	If Parental Lock is turned on, when you enter the correct password to unblock the channels, you can press <b>P-LOCK</b> to block the channels again.
40	ZOOM	Press to select the aspect ratio. For more information, see "Adjusting the TV picture" on page 23.
41	PICT	Press to select the video modes. You can select <b>Vivid</b> , <b>Standard</b> , <b>Energy Savings</b> , <b>Theater</b> , <b>Sports</b> , or <b>Custom</b> . For more information, see "Adjusting the TV picture" on page 23.

- 2 Insert two AA batteries into the battery compartment. Make sure that the + and - symbols on the batteries align with the + and - symbols in the battery compartment.
- 3 Replace the cover.

**Warnings**

- Batteries should not be exposed to excessive heat, such as sunshine, heat registers, or fire.
- Battery chemicals can cause a rash. If the batteries leak, clean the battery compartment with a cloth. If chemicals touch your skin, wash immediately.
- Make sure that batteries are disposed of correctly. Do not burn or incinerate.

**Notes**

- Do not mix batteries of different types.
- Do not mix old and new batteries.
- Remove batteries when the charge is depleted.
- If the remote control is not going to be used for an extended period of time, remove the batteries.

**Aiming the remote control**

**To aim the remote control:**

- Point the remote control toward the remote control sensor on the front of your TV.

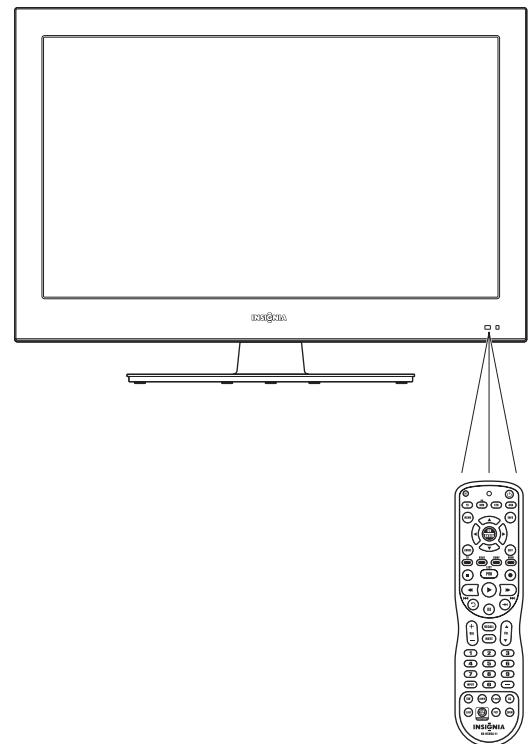

**Using the remote control**

**Installing remote control batteries**

**To install the remote control batteries:**

- 1 While pressing the release button on the battery compartment cover on the back of the remote, lift the cover off the remote.

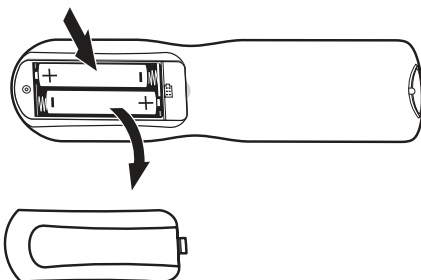

**Notes**

- Do not expose the remote control to shock.
- Do not expose the remote control to liquids and do not use the remote control in an area with high humidity.
- Do not place the remote control in areas of high heat or direct sunlight. The heat may warp the battery case.
- The remote control may not work correctly if sunlight or bright light is shining on the remote control sensor. To correct this problem, move your TV or use the remote control closer to the remote control sensor.

## Using the remote control holder

Your TV comes with a remote control holder you can put the remote control in when you are not using it. You can put the holder on a table or mount it on a wall.

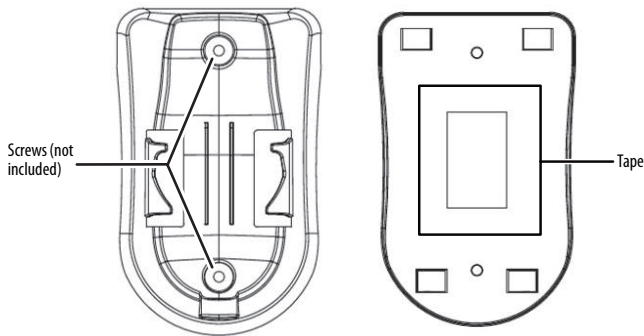

### Note

Different types of walls may require different types of screws. If you want to wall mount the remote control holder, make sure that you use the correct screws for the type of wall. (Screws are not provided.)

## Programming your universal Insignia remote control

To program your remote to control home theater devices, follow these steps.

### To program your remote control:

- 1 Find the codes for the devices you want to program in "Manufacturers' codes" on page 45 and write them down or highlight them.
- 2 Turn on the device (for example, a DVD player) and, if needed, load media such as a DVD.
- 3 Press the device button on the TV remote for the device that you want to program (**TV**, **DVD**, **STB**, or **AUX**).
- 4 Press and hold **SET** until the red LED blinks twice, then release.
- 5 Enter the first five-digit code for the device and brand that you want to program. The LED blinks once as each digit is entered. If the code is valid, the LED blinks twice.

### Note

If the LED does not blink twice, repeat steps 2 to 4 and try entering the code again.

- 6 Aim the remote at the device and press **⏻** (power). The device should turn off. If it does not, repeat Steps 3 through 5, trying each code for your brand until you find one that works. If you cannot find a code that works, see "Searching for your code" below.
- 7 Repeat Steps 1 to 5 for the other devices you want to control. For future reference, write down each working device code.

## Searching for your code

If your device does not respond to the remote control after trying all codes listed for your brand, or if your brand is not listed, try searching for your code.

### To search for your code:

- 1 Turn on the device you want to control.
- 2 Press the device button on your TV remote control (**TV**, **DVD**, **STB**, or **AUX**) once.
- 3 Press and hold **SET** until the red LED blinks twice, then release.
- 4 Enter **9 9 1**. The LED blinks twice.
- 5 Press the number that matches your device type.
  - **0**—Cable converters, video accessories, satellite receivers
  - **1**—TVs
  - **2**—VCRs, DVD players, Blu-ray Disc players
  - **3**—Audio amplifiers, audio amplifiers/tuners, CD players
- 6 Aim the remote at the device and press **⏻** (power). The remote sends IR codes from its library to the selected device, starting with the most popular code first. If the device responds, go to Step 8.
- 7 If the device does not respond, press **CH ▲** and the remote tests the next code for that device type. Continue to press **CH ▲** until the device turns off.

### Note

Press **CH ▼** to try the previous code.

- 8 Now that you have found the correct code, press **SET** to save the code that worked for your device. The LED blinks twice to indicate that the code has been saved.
- 9 To search for other device codes, repeat Steps 1 to 8.

## Checking the codes

If you have set up the remote using the procedure in "Searching for your code" on page 10, you may need to find out which five-digit code is operating your equipment.

### To find out which code is assigned to your TV (for example):

- 1 Press **TV** once.
- 2 Press and hold **SET** until the red LED blinks twice, then release.
- 3 Enter **9 9 0**. The LED blinks twice.
- 4 To view the code for the first digit, press **1**. Count the red LED blinks (for example, three blinks = 3), then write down the number in the appropriate code listing at the top of this column.

### Note

If the LED does not blink, the code digit is 0.

- 5 Repeat Step 4 for the four remaining digits, using **2** for the second digit, **3** for the third digit, **4** for the fourth digit, and **5** for the fifth digit.

- To check for other device codes, repeat Steps 1 through 5, substituting the device button for the device you would like to check.

### Using learning

This universal remote control includes a learning feature so you can add functions that are unique to your home entertainment devices (such as VCR Tracking Up or Down). However, there are some considerations to keep in mind.

#### Precautions

- Your original remote controls must be in working order for learning to work properly.
- Learned buttons are mode-specific, so each one can store a unique function for each mode.
- Do not use the following buttons for learning: **Device** Buttons, **SET**, or ● (record).
- Learning capacity is approximately 42 to 75 buttons, depending on the code being learned.
- Certain device functions are not learnable, including multi-frequency types, some high frequency functions, and other unusual formats.
- For optimum learning, avoid high levels of ambient light such as natural sunlight or energy-efficient fluorescent lights.

#### Note

Have your original remote controls handy before programming learning.

### Programming a learned button

#### To program a learned button:

- Place your Insignia remote control head-to-head (about 2" apart) from your original remote control (the one that came with the device).
- Locate the button on your original remote control that you want the Insignia remote control to learn. Press the mode button you want to learn functions on.
- Press and hold **SET** until the LED blinks twice, then release.
- Enter **9 7 5**. The LED blinks twice.

#### Note

If more than 10 seconds pass between button presses, the remote exits programming. If the LED displays one long flash instead, replace the batteries. If the remote control continues to display one long flash, the remote control cannot learn a new button.

- Press the button on the Insignia TV remote you want to program. The feedback LED stays lit for three seconds, indicating that the remote is ready to learn.
- On the original remote, press and hold the button to be learned. Continue holding the button on the original remote until the Insignia's LED blinks twice.

#### Note

If the red LED displays one long blink, a learning error has occurred. Try repeating this step again until a successful capture occurs. If the function is still not captured, press and hold **SET** to exit programming and review the Precautions" above. After reviewing, start programming again at Step 1.

- Repeat Steps 4 and 5 to program another button. Once you have completed programming all the buttons you want, press and hold **SET** until the LED blinks twice to save all data learned.

### Deleting a single learning button

This process returns the button to its original programming for the mode you select. You can also delete learned programming by teaching a different function to the button (see "Programming a Learned Button" above).

#### Note

If more than 10 seconds pass between button presses, the remote exits programming. If the LED displays one long flash instead, replace the batteries. If the remote control continues to display one long flash, the remote control cannot learn a new button.

#### To delete a single learned button:

- Press the mode button that you want to remove the learned button from.
- Press and hold **SET** until the LED blinks twice, then release.
- Enter **9 7 6**. The LED blinks twice.
- Press the button containing the learned function to be deleted, twice. The LED blinks twice and programming ends.

### Deleting all learned buttons in a specific mode

#### Note

If more than 10 seconds pass between button presses, the remote exits programming. If the LED displays one long flash instead, replace the batteries. If the remote control continues to display one long flash, the remote control cannot learn a new button.

#### To delete all learned buttons in a specific mode:

- Press and hold **SET** until the LED blinks twice, then release.
- Press **9 7 6**. The LED blinks twice.
- Press a mode button twice (for example, **TV**, **DVD**, **STB**, or **AUX**) to clear all the learned buttons for that mode. The LED blinks twice and programming ends.

### Changing the volume lock

Volume Lock sets the volume and mute buttons to the device you select, regardless of what mode you are in. For example, if you lock the volume to your DVD player and then go to TV mode, when you press the volume button on your Insignia remote, the volume will change on the DVD player and not on your TV.

#### To lock the volume control:

- Press and hold **SET** until the red LED blinks twice, then release.
- Enter **9 9 3**, the LED blinks twice.
- Press the mode button for the device you want to control (for example, TV).
- The LED blinks twice. Now when you press **VOL+**, **VOL-**, or **Mute**, the selected device controls the volume regardless of the current mode.

### To unlock all volume control:

- 1 Press and hold **SET** until the red LED blinks twice, then release.
- 2 Enter **9 9 3**, the LED blinks twice.
- 3 Press **VOL+**. The LED blinks four times. Volume is independently controlled for all programmed devices.

### To unlock a single device's volume control:

- 1 Press the device mode button (**TV, DVD, STB, or AUX**).
- 2 Press and hold **SET** until the red LED blinks twice, then release.
- 3 Enter **9 9 3**. The LED blinks twice.
- 4 Press **VOL-**. The red LED blinks four times. Volume is independently controlled for the selected devices.

### Programming channel lock

Channel control can be locked so that the Insignia remote controls a single device's channel-changing functions, regardless of operating mode. This is often enabled by users who watch all broadcast TV through one device, such as a cable set-top box. The affected buttons are **1** through **0**, **CH ▲**, **CH ▼**, and **RECALL**.

### To lock all channel controls to one device:

- 1 Press the mode button for the device that you want to use for changing channels, such as **STB** for your cable set top box.
- 2 Press and hold **SET** until the mode LED blinks twice, then release.
- 3 Enter **9 7 3**. The mode LED blinks twice.
- 4 Press **CH ▲** once. The mode LED blinks twice.

Now, regardless of what mode you select, the channel buttons will only change channels on the assigned device.

### To unlock channel locks:

- 1 Press and hold **SET** until the mode LED blinks twice, then release.
- 2 Enter **9 7 3**. The mode LED blinks twice.
- 3 Press **CH ▼** once. The mode LED blinks four times.

Now the channel functions will correlate to the active mode (for example, press **CH ▲** in **TV** mode and the TV changes channel accordingly).

### Using buttonmover

Your Insignia universal remote control includes a buttonmover feature that lets you copy buttons from one mode (such as source mode) to another mode (such as destination mode) or to a different button in the same mode.

#### Note

Do not use any of the Device Buttons, **⏻** (power), **RECORD**, or **SET** as a source or destination button.

### To move buttons in the same device mode:

- 1 Press the device button (**TV, DVD, STB, or AUX**).
- 2 Press and hold **SET** until the LED blinks twice, then release.
- 3 Press **9 9 4**. The LED blinks twice.

- 4 Press the button you want to move.
- 5 Press the new button that should perform the function. The LED blinks twice.
- 6 Repeat Steps 1-5 to move additional buttons.

### To move buttons to a different device mode:

- 1 Press and hold **SET** until the LED blinks twice, then release.
- 2 Press **9 9 4**. The LED blinks twice.
- 3 Press the device button that contains the function you want to move (for example, **DVD**).
- 4 Press the button you want to move (such as **Play**).
- 5 Press the device button that you want to move the function to (such as **TV**).
- 6 Press the button in the new mode that should perform the function (for example, **Play**). The LED blinks twice.
- 7 Repeat Steps 1-6 to move additional buttons.

### To restore all buttonmoved data in a specific mode:

- 1 Press and hold **SET** until the LED blinks twice, then release.
- 2 Press **9 9 4**. The LED blinks twice.
- 3 Press the device button you want to remove all buttonmoved data from twice. The LED blinks twice.
- 4 Repeat for each device you want to restore.

### To restore original button function:

- 1 Press the device button for which you want to remove the buttonmoved data from a specific button.
- 2 Press and hold **SET** until the LED blinks twice, then release.
- 3 Enter **9 9 4**. The LED blinks twice.
- 4 Press the button you want to remove the buttonmoved data from twice. The LED blinks twice.
- 5 Repeat Steps 1-4 for additional buttons you want to remove.

### Programming macros

Your Insignia universal remote control includes the ability to program any button (other than the **SET** button) with a macro function. Each one can be set up to perform a pre-programmed set of sequential button presses with the press of a single button. A macro can be used to control a home theater operation, to set a favorite channel, or for other functions you would like to control with one button press. Each macro button can hold up to 15 button presses, total.

#### Note

Programming a new macro over an existing one erases the original macro.

### To program a mode-independent macro:

- 1 Press and hold **SET** until the red LED blinks twice, then release.
- 2 Press **9 9 5**. The LED blinks twice.
- 3 Press the button you want to assign to a macro.



- 4 Enter the series of commands you want the macro to execute (up to 15 commands).
- 5 Press and hold **SET** until the red LED blinks twice, then release.

Now, when you press the preset macro button, the remote sends the series of commands you have entered, regardless of what mode you are in. For example, you could program a macro button to turn on both your TV and cable box and select a particular channel.

**Note**

To clear the macro, repeat Steps 1-5, but do not enter a series of commands at Step 4.

**To program a mode-dependent macro:**

- 1 Press the device mode button (**TV, DVD, STB, or AUX**).
- 2 Press and hold **SET** until the LED blinks twice, then release.
- 3 Press **9 7 8**. The LED blinks twice.
- 4 Press the button you want to assign to a macro.
- 5 Enter the series of commands you want the macro to execute (up to 15 commands).
- 6 Press and hold **SET** until the red LED blinks twice, then release.

Now, when you press the macro button, the remote sends the series of commands you have entered, but only if you are in the mode you selected in Step 1. For example, you could program the macro button to turn on both your TV and cable box and select a particular channel, but only if you are in TV mode. If you are in DVD mode, this button does not execute the macro you set up in TV mode.

**Note**

To clear the macro, repeat Steps 1-6, but do not enter a series of commands at Step 5.

**Programming a universal remote control to work with your TV**

You can operate your Insignia TV with a new or existing universal remote control.

**To program a universal remote control:**

- 1 See the table below for common codes. If you have problems programming your remote or need a different remote control code, visit [www.insigniaproducts.com](http://www.insigniaproducts.com) for the latest remote control code information.

Insignia TV codes for universal remote controls (for all Insignia TVs manufactured after Jan. 1, 2007)				
Universal remote control makes and models				
Philips PHDVD5, PH5DSS, PMDVR8, PDVR8	DirectTV RC23	RCA RCU807	One for All URC-6690	Sony RM-VL600
<b>115</b>	<b>10463</b>	<b>135</b>	<b>0464</b>	<b>8043</b>
Set-top box makes and models				
Comcast M1057	Dish Network VIP508, VIP622	Motorola DRC800	TIVO Series 3, HD	
<b>0463</b>	<b>720</b>	<b>0463</b>	<b>0091</b>	

Codes for other remote controls are available online at: [www.insigniaproducts.com](http://www.insigniaproducts.com)

**Tips**

- The brand name is often visible on the front of the universal remote control, and the model number is often visible on the back.
- If your universal remote control isn't listed on the chart, refer to your universal remote control's instructions and try codes for the brands Orion, Emerson, Memorex, Sansui, Sylvania, or Zenith. You may need to try several codes before finding a match.

- 2 Follow your universal remote control's instructions to enter the TV code you found in Step 1.

**Tips**

- If your universal remote control has a code search feature, run a code search to identify a code that matches your TV. See your universal remote control's instructions for details.
- If your universal remote control has a "Learn" feature, you can manually program it using the Insignia TV remote to "teach" the commands one at a time. See your universal remote control's instructions for details.

- 3 If all else fails, you must use a different universal remote control that can operate both your set-top box and your TV. Four such remotes are listed on the chart, but many other compatible models are available in the market.

For more help, go to [insigniaproducts.com](http://insigniaproducts.com) or call technical support for your universal remote control or set-top box manufacturer, or call the Insignia Customer Care Center. For US and Canada markets, call 1-877-467-4289. For Mexico markets, call 01 800-926-3000 .

# Making connections

**Cautions**

- Check the jacks for position and type before making any connections.
- Loose connections can result in image or color problems. Make sure that all connections are tight and secure.
- The external audio/video equipment shown may be different from your equipment. If you have questions, refer to the documentation that came with your equipment.
- Always unplug the power cord when connecting external equipment.

## Connecting power

**To connect the power:**

- Connect the AC power cord to the AC connector on the back of your TV, then plug the other end into a power outlet.

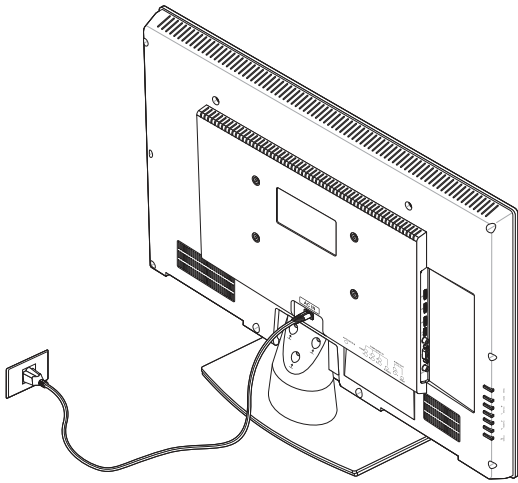

**Notes**

- Your TV should only be operated from the power source indicated on the label.
- Always unplug the AC power cord from the power outlet when you will not be using your TV for an extended period of time.

## Connecting an antenna or cable TV without a cable box

**To connect an antenna or cable TV without a cable box:**

- Connect a coaxial cable (not provided) to the **ANT/CABLE IN** jack on the back of your TV and to the antenna or cable TV wall jack.

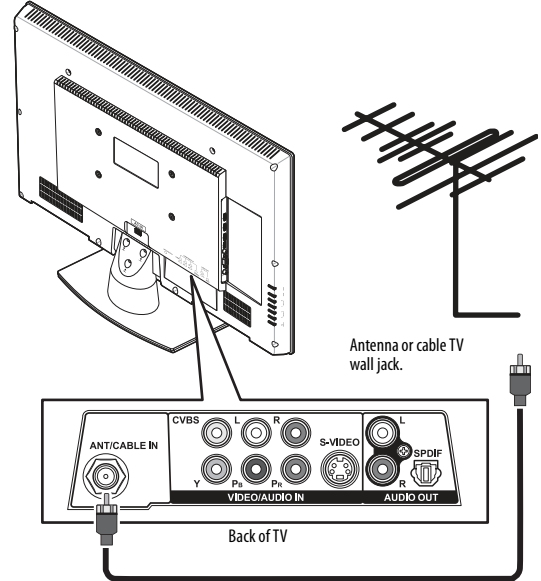

**Notes**

- Use a 75 ohm cable to eliminate interference and noise from radio waves.
- Do not bundle the 75 ohm cable with the power cord or other cables.
- If the antenna is not installed correctly, contact qualified service personnel to correct the problem.

## Connecting a cable or satellite box

Many cable or satellite TV boxes have more than one connection type. To get the best video, you should use the best connection type available.

Connection type	Video quality
HDMI	Best
Component	Better than S-Video, composite, or coaxial
S-Video	Better than composite or coaxial
Composite	Better than coaxial
Coaxial	Good

### To connect a cable or satellite box:

- 1 Connect the incoming cable from the cable wall jack to the cable-in jack on the cable box.

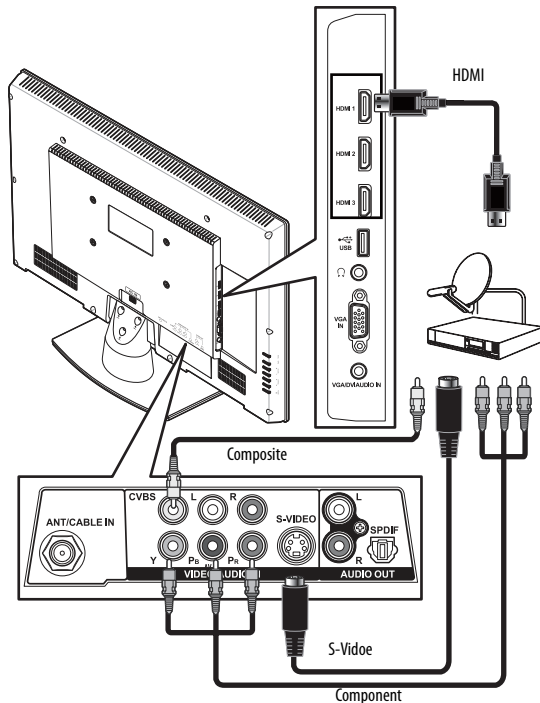

- 2 Depending on the jacks available on the cable or satellite TV box, connect a cable (not provided) from the outgoing jacks on the cable or satellite TV box to the corresponding jacks on the back of your TV. The connection can be to an **HDMI** jack, the **Y/Pb/Pr** (component video) jacks, **S-VIDEO** jack or the **CVBS** (composite) jack.
- 3 If you use the **Y/Pb/Pr** (component video) jacks, **S-VIDEO** jack or the **CVBS** (composite) jack, connect an audio cable (not provided) to the **L/R** (audio in) jacks.

#### Note

If the cable or satellite TV box does not have an HDMI, component, or composite jack, connect the cable or satellite TV box to the **ANT/CABLE IN** jack on the back of your TV. For more information, see "Connecting an antenna or cable TV without a cable box" on page 14.

### Connecting an HDMI device

#### Note

If your device has an HDMI connection, we recommend that you use the HDMI connection to get the best quality possible.

#### To connect an HDMI device:

- 1 Make sure that your TV's power cord is unplugged and the HDMI device is turned off.
- 2 Connect an HDMI cable (not provided) to the **HDMI 1**, **HDMI 2**, or **HDMI 3** jack on the side of your TV and to the **HDMI OUT** jack on the HDMI device.

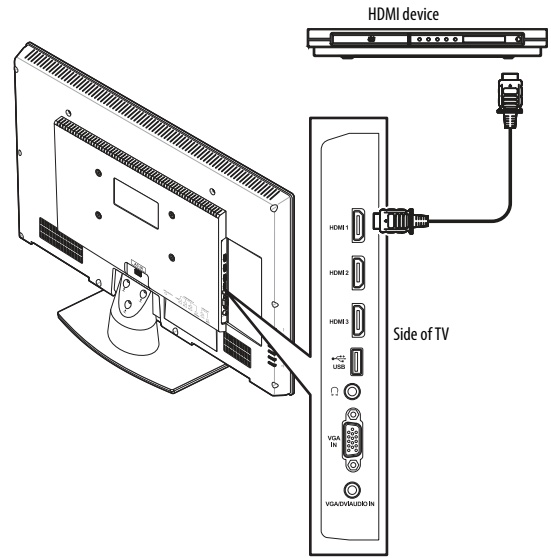

#### To play from an HDMI device:

- 1 Turn on your TV, then press **INPUT** to open the *Input Source* list.
- 2 Press **▲** or **▼** to select **HDMI 1**, **HDMI 2**, or **HDMI 3**, then press **OK/ENTER**.

#### Note

You can also press **HDMI** repeatedly to select the HDMI device.

- 3 Turn on the HDMI device, then set it to the output mode. See the documentation that came with the device for more information.

## Connecting a DVI device

### Note

A DVI device must be connected to the **HDMI 1** jack. If you connect a DVI device to another **HDMI** jack, you will not hear audio.

### To connect a DVI device:

- 1 Make sure that your TV's power cord is unplugged and the DVI device is turned off.
- 2 Connect a HDMI-DVI adapter to one end of an HDMI cable, then connect the adapter to the DVI OUT jack on the DVI device.

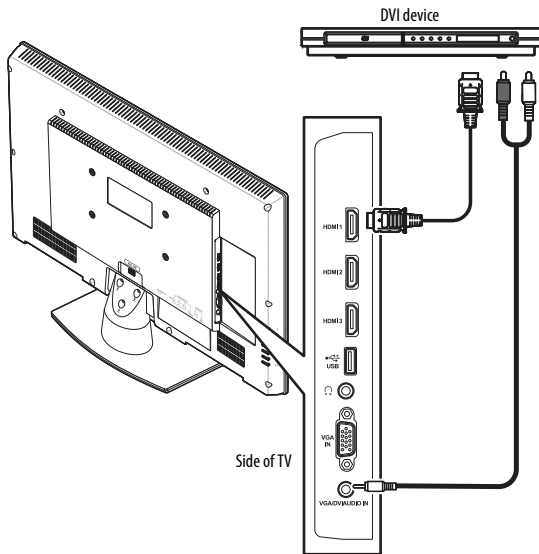

- 3 Connect the other end of the HDMI cable to the **HDMI 1** jack on the side of your TV.
- 4 Connect an audio cable to the **VGA AUDIO IN** jack on the side of your TV and to the **AUDIO OUT** jack on the DVI device.

### To play from an DVI device:

- 1 Turn on your TV, then press **INPUT** to open the *Input Source* list.
- 2 Press **▲** or **▼** to select **HDMI 1**, then press **OK/ENTER**.

### Note

You can also press **HDMI** repeatedly to select the DVI device.

- 3 Turn on the DVI device, then set it to the output mode. See the documentation that came with the device for more information.

## Connecting a component video device

### To connect a component video device:

- 1 Make sure that your TV's power cord is unplugged and the component video device is turned off.
- 2 Connect a component video cable (provided) to the **Y/Pb/Pr** (component video) jacks on the back of your TV and to the **COMPONENT OUT** jacks on the component video device.

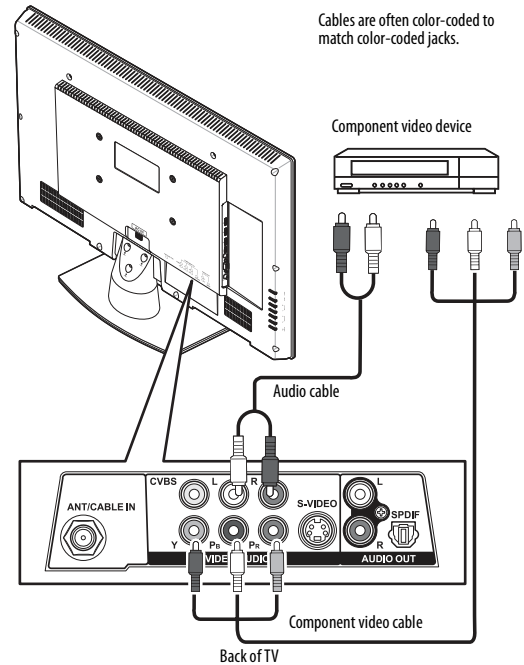

- 3 Connect an audio cable to the **L/R** (audio in) jacks on the back of your TV and to the **L/R AUDIO OUT** jacks on the component video device.

### To play from the component video device:

- 1 Turn on your TV, then press **INPUT** to open the *Input Source* list.
- 2 Press **▲** or **▼** to select **Component**, then press **OK/ENTER**.

### Note

You can also press **COMP** to select the component video device.

- 3 Turn on the component video device, then set it to the output mode. See the documentation that came with the device for more information.

### Note

The **Y/Pb/Pr** (component video) jacks shares the audio jacks with the **S-VIDEO** and **CVBS** jacks.

## Connecting an S-Video device

### To connect an S-Video device:

- 1 Make sure that your TV's power cord is unplugged and the component video device is turned off.
- 2 Connect an S-Video cable to the **S-VIDEO** jack on the back of your TV and to the **S-VIDEO OUT** jack on the S-Video device.

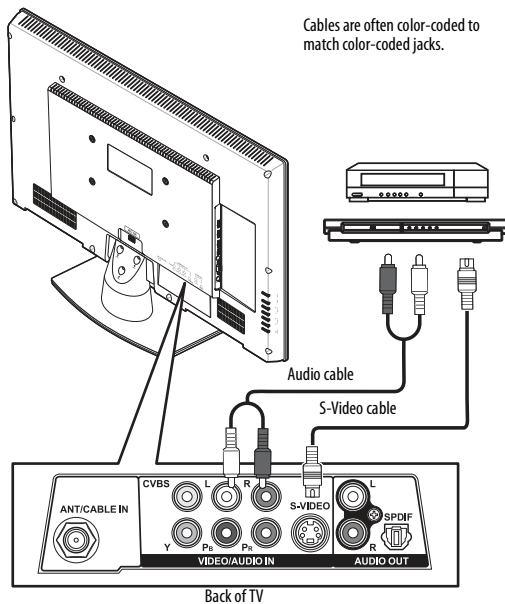

- 3 Connect an audio cable to the **L/R** (audio in) jacks on the back of your TV and to the **L/R AUDIO OUT** jacks on the S-Video device.

### To play from the S-Video device:

- 1 Turn on your TV, then press **INPUT** to open the *Input Source* list.
- 2 Press **▲** or **▼** to select **AV**, then press **OK/ENTER**.

#### Note

You can also press **VIDEO** to select the S-Video device.

- 3 Turn on the S-Video device, then set it to the output mode. See the documentation that came with the device for more information.

#### Note

The **S-VIDEO** jack shares the audio jacks with the **Y/Pb/Pr** (component video) and **CVBS** jacks.

## Connecting a VCR

### To connect a VCR:

- 1 Make sure that your TV's power cord is unplugged and the VCR is turned off.
- 2 Connect an AV cable (not provided) to the **CVBS** and **L/R** (audio in) jacks on the back of your TV and to the **AV OUT** jacks on the VCR.

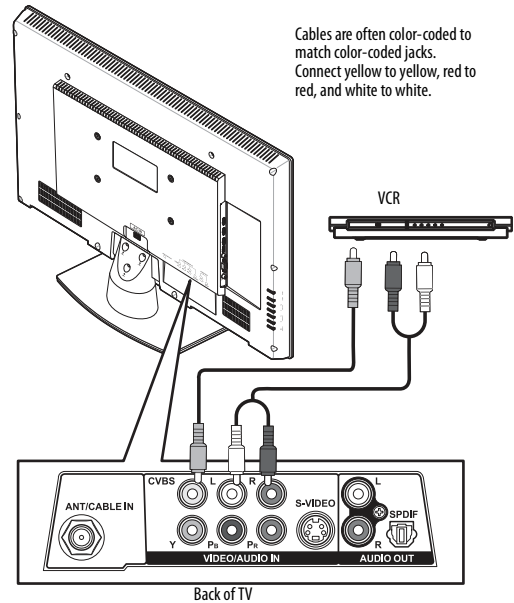

### To play from the VCR:

- 1 Turn on your TV, then press **INPUT** to open the *Input Source* list.
- 2 Press **▲** or **▼** to select **AV**, then press **OK/ENTER**.

#### Note

You can also press **VIDEO** to select the VCR.

- 3 Turn on the VCR, insert a videotape, then press **PLAY** on the VCR.

#### Note

The **CVBS** jack shares the audio jacks with the **Y/Pb/Pr** (component video) and **S-VIDEO** jacks.

## Connecting a camcorder or game console

### Note

If your camcorder or game console has an HDMI connection, we recommend that you use the HDMI connection to get the best quality possible.

### To connect a camcorder or game console:

- 1 Make sure that your TV's power cord is unplugged and the camcorder or game console is turned off.
- 2 Connect an AV cable (not provided) to the **CVBS** and **L/R** (audio in) jacks on the back of your TV and to the **AV OUT** jacks on the camcorder or game console.

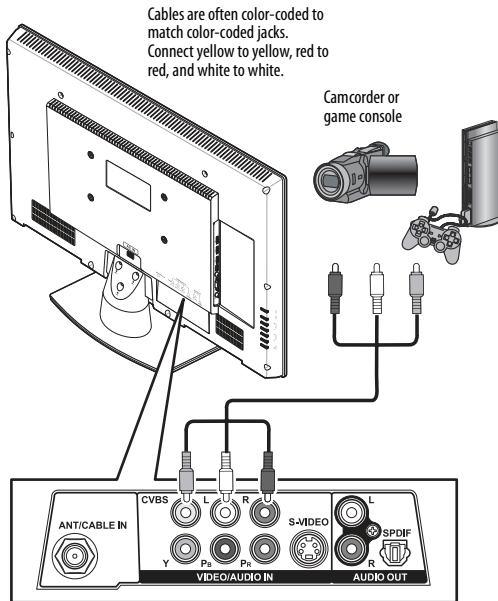

### To play from the camcorder or game console:

- 1 Turn on your TV, then press **INPUT** to open the *Input Source* list.
- 2 Press **▲** or **▼** to select **AV**, then press **OK/ENTER**.

### Note

You can also press **VIDEO** to select the camcorder or game console.

### Note

The **CVBS** jack shares the audio jacks with the **Y/Pb/Pr** (component video) and **S-VIDEO** jacks.

## Connecting a computer

### Tip

Some computers have an HDMI jack. You can use an HDMI cable to connect the computer for a better picture.

### To connect a computer:

- 1 Make sure that your TV's power cord is unplugged and the computer is turned off.
- 2 Connect a VGA cable (not provided) to the **VGA IN** jack on the side of your TV and to the **VGA** jack on the computer.

### Note

The VGA cable should be a 15-pin D-Sub (analog RGB) cable.

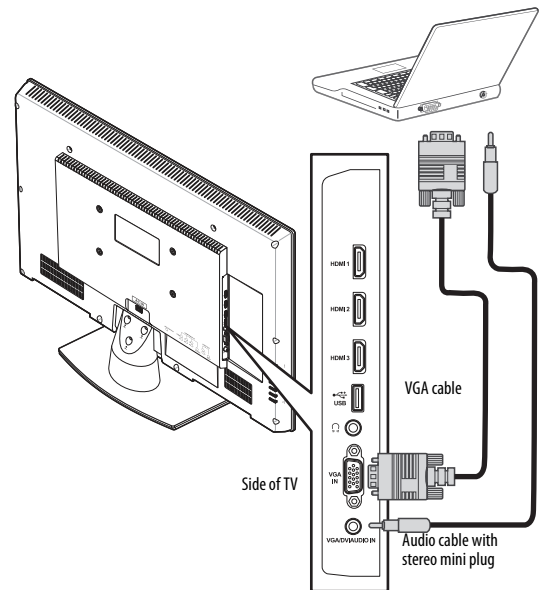

- 3 Connect an audio cable with stereo mini plug to the **VGA AUDIO IN** jack on the side of your TV and to the **LINE OUT** or **AUDIO OUT** jack on the computer.

### To play video from the computer:

- 1 Turn on your TV, then press **INPUT** to open the *Input Source* list.
- 2 Press **▲** or **▼** to select **VGA**, then press **OK/ENTER**.
- 3 Turn on the computer and adjust the display properties if necessary.

## Connecting a USB device

### To connect a USB device:

- Plug a USB device, such as a flash drive, into the **USB** port on the side of your TV.

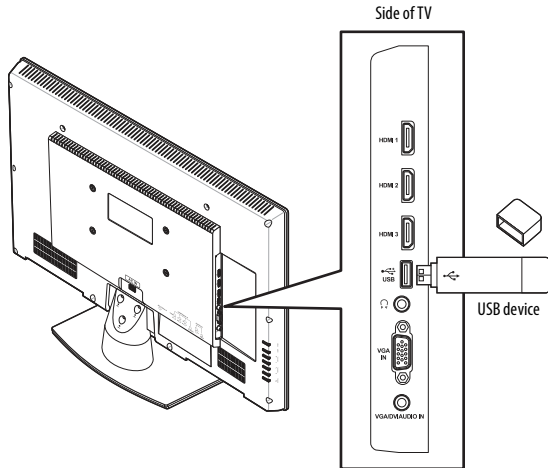

#### Caution

Never remove the USB device or turn off the TV while using the USB device. You may lose data or damage the USB device.

### To play from a USB device:

- 1 Turn on your TV, then press **INPUT** to open the *Input Source* list.
- 2 Press **▲** or **▼** to select **USB**, then press **OK/ENTER**.

#### Note

For more information, see "Using USB" on page 40.

## Connecting headphones

The TV speakers are muted when headphones are attached.

#### Warning

Loud noise can damage your hearing. When using headphones, use the lowest volume setting on your headphones that still lets you hear the sound.

### To connect headphones:

- Connect headphones to the  (headphone) jack on the back of your TV.

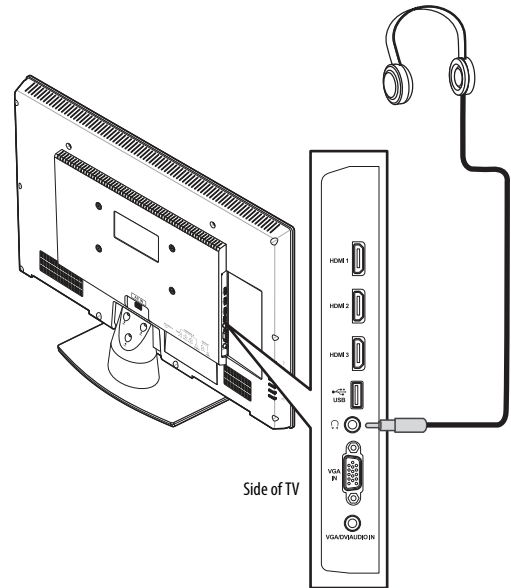

## Connecting a digital sound system

### To connect a digital sound system:

- 1 Make sure that your TV's power cord is unplugged and the sound system is turned off.
- 2 Connect a digital optical audio cable to **SPDIF** jack on the back of your TV and to the digital optical audio jack on the digital sound system.

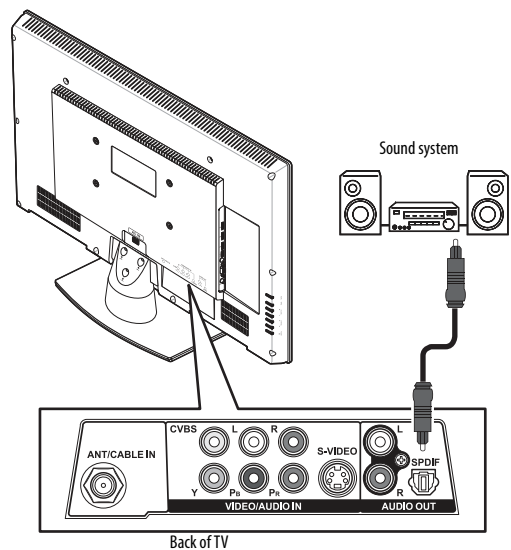

## Connecting an analog sound system

### To connect an analog sound system:

- 1 Make sure that your TV's power cord is unplugged and the sound system is turned off.
- 2 Connect an audio cable to the **L/R** (audio out) jacks on the back of your TV and to the **AUDIO IN** jacks on the sound system.

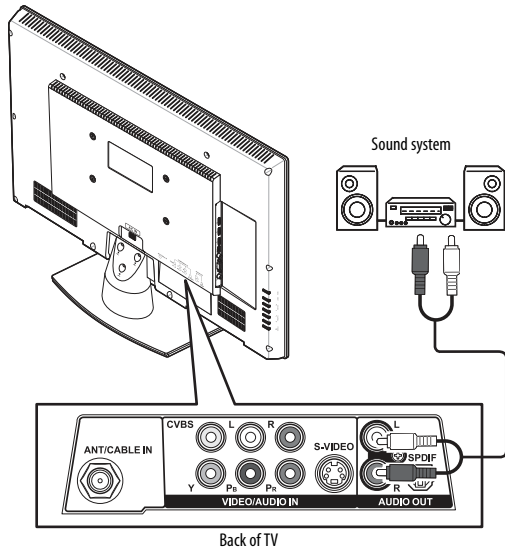

- 3 Press **▲** or **▼** to highlight the language you want, then press **OK/ENTER**. The *Choose your Time Setting* screen opens.

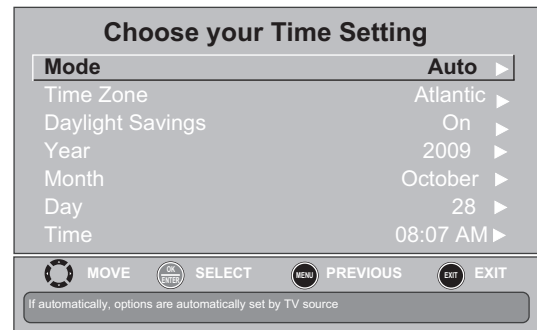

- 4 Press **▲** or **▼** to highlight **Mode**, then press **◀** or **▶** to select **Custom** (to set the date and time manually) or **Auto** (to set the date and time automatically from a TV signal source based on the time zone your select).
- 5 Press **▲** or **▼** to highlight **Time Zone**, then press **◀** or **▶** to select your time zone. You can select **Eastern, Central, Mountain, Pacific, Alaska, Hawaii, Atlantic, or Newfoundland**.
- 6 Press **▲** or **▼** to highlight **Daylight Savings**, then press **◀** or **▶** to select **On** (if your viewing area observes Daylight Savings Time) or **Off** (if your viewing area does not observe Daylight Savings Time).
- 7 If you selected **Custom** for **Mode**, set the date by pressing **▲** or **▼** to highlight **Year, Month, or Day**, then press **◀** or **▶** to adjust the setting.
- 8 If you selected **Custom** for **Mode**, set the time by pressing **▲** or **▼** to highlight **Time**, then pressing **◀** or **▶** to select the hour, minute, or AM/PM field. Press **▲** or **▼** to adjust the setting.
- 9 Press **OK/ENTER**. The *Choose your Picture Mode* screen opens.

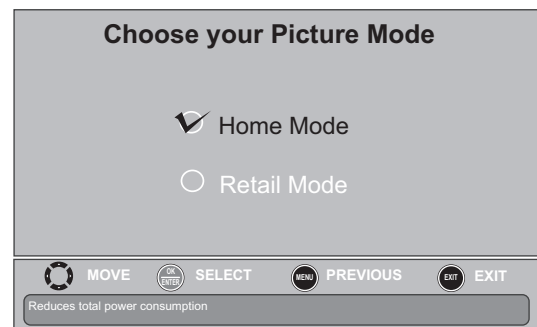

## Turning on your TV for the first time

The first time you turn on your TV, the Setup Wizard opens. The Setup Wizard guides you through setting up basic settings including the menu language, time setting, picture mode, TV signal source, and the channel list.

### To set up your TV:

- 1 Make sure that you have:
  - Installed the remote control batteries. (See page 9 for details.)
  - Connected an antenna, cable TV, or satellite TV. (See page 14 for details.)
  - Connected the power cord. (See page 14 for details.)
- 2 Press **⏻** (power) to turn on your TV. The *Choose your menu language* screen opens.





- 10** Press **▲** or **▼** to highlight **Home Mode** or **Retail Mode**, then press **OK/ENTER**.

If you selected **Retail Mode**, a message appears "If you select Retail Mode, then Energy saving is not realized." Select **Yes** to continue, or select **No** to change your selection.

The *Choose your TV source* screen opens.

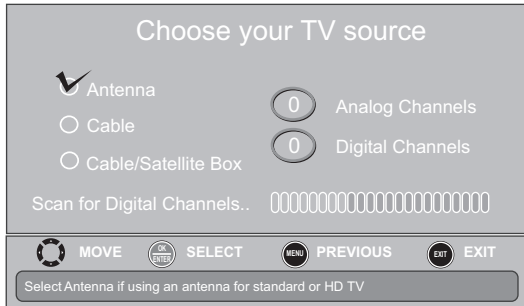

- 11** Press **▲** or **▼** to highlight **Antenna**, **Cable**, or **Cable/Satellite Box** (if your cable TV uses a box, select **Cable/Satellite Box**), then press **OK/ENTER**. If you chose **Antenna** or **Cable**, your TV automatically starts scanning for channels available in your viewing area. If you chose **Cable/Satellite box**, your TV does not need to scan for channels.

During auto channel search, your TV searches for digital channels first. When the digital channel search is complete, a message appears asking if you want to search for analog channels. Select **Yes** to continue searching for analog channels, or select **No** to stop searching for channels.

**Note**  
You can press **EXIT** to stop the auto channel search, but you will need to run the auto channel search again to create a channel list.

- 12** To watch TV, press **INPUT**, press **▲** or **▼** to highlight **TV** in the *Input Source* list, then press **OK/ENTER**.

**Note**  
You can select a different video input source.

## Understanding the basics

**Note**  
Unless otherwise noted, all tasks in this section are based on using the remote control.

### Turning your TV on or off

**To turn your TV on or off:**

- 1 Make sure that the power cord is connected to a power outlet.
- 2 Press **⏻** (power) to turn on your TV. The power indicator LED turns blue.
- 3 Press **⏻** (power) again to turn off your TV. Your TV enters Standby mode and the power indicator LED turns red.

**Warning**  
When your TV is in standby mode, it is still receiving power. To completely disconnect power, unplug the power cord.

**Note**  
If your TV does not receive an input signal for several minutes, it automatically goes into standby mode.

### Selecting the video input source

**To select the video input source:**

- 1 Turn on your TV, then press **INPUT**. The *Input Source* list opens.

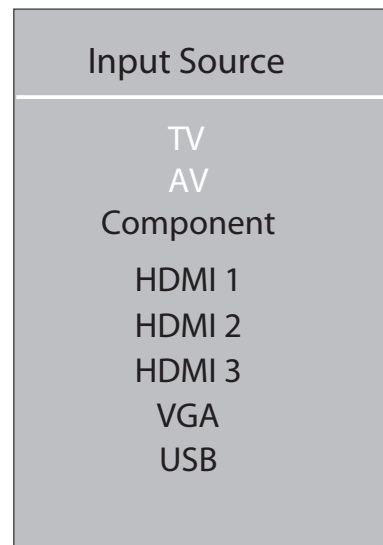

- 2 Press **▲** or **▼** to highlight a video input source, then press **OK/ENTER**.

You can also press a direct input button to select the video input source.

- Press **TV** to select TV.
- Press **VIDEO** to select AV.
- Press **HDMI** once to select **HDMI 1**. Press twice to select **HDMI 2**. Press three times to select **HDMI 3**.

## On-screen menu overview

### Notes

- Depending on the signal source selected, you may see different options on your screen. The following menus are shown in TV mode (except the USB menu).
- Menu items that are not selectable are grayed out.
- Menus in this manual are described in TV mode, unless otherwise indicated.
- The screens shown in this manual are for explanation purposes and may vary from the actual screens on your TV.

### PICTURE menu (TV mode)

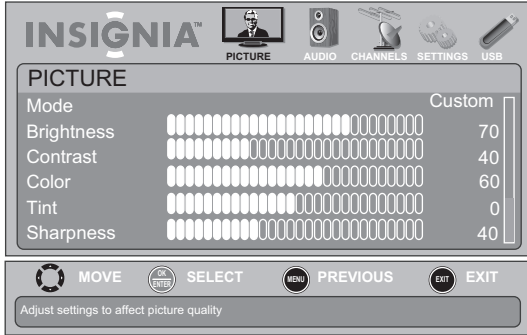

### AUDIO menu (TV mode)

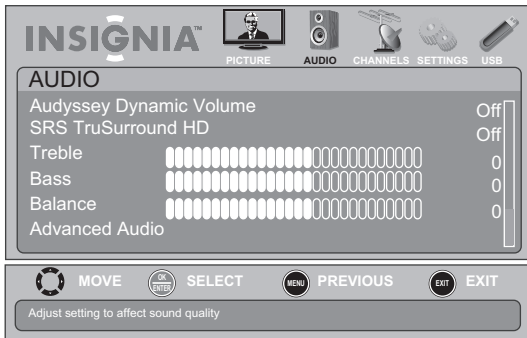

### CHANNELS menu (TV mode)



### SETTINGS menu (TV mode)



### USB menu (USB mode)



## Navigating the menus

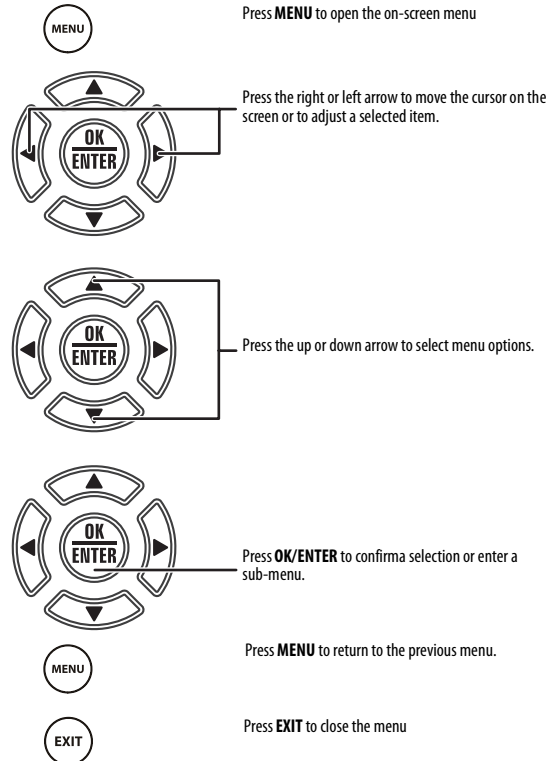

## Selecting a channel

### To select a channel:

- Press **CH ▲/CH ▼** to go to the next or previous channel on the memorized channel list.
- Press the number buttons to enter the channel number you want, then wait for the channel to change or press **OK/ENTER** to immediately change the channel.
- To select a digital sub-channel, press the number buttons to select the main digital channel, press — (dash), then press the number button for the sub-channel. Wait for the channel to change, or press **OK/ENTER** to immediately change the channel. For example, to tune to channel 5.1, press **5**, — (dash), then **1**.
- Press **RECALL** to go to the last viewed channel.
- Press **FAV** to open the favorite channel list, press **▲** or **▼** to highlight a channel, then press **OK/ENTER**.

### Note

If a list has more than one page, press **▲** or **▼** to scroll through the pages.

## Adjusting the volume

### To adjust the volume:

- Press **VOL +** or **VOL -** to increase or decrease the volume.
- Press **MUTE** to turn off the sound. Press **MUTE** again to turn the sound back on.

## Displaying additional information

### To view channel information:

- Press **INFO** to view an information banner. The information banner shows the current program information such as channel number, video input source, and resolution.
  - Digital channel information—Displays the channel number, station name, channel label, broadcast program name, TV rating, signal type, audio information, resolution, CC mode, current time, and current program start and end times.
  - Analog channel information—Displays channel number, channel label (if preset), signal type, audio information, and resolution.
- Press **GUIDE** to show the digital program guide, which may view a list of available programs, program times, and program summaries, depending on the information provided by the broadcaster.

## Adjusting the picture

### Note

Unless otherwise noted, all tasks in this section are based on using the remote control.

## Adjusting the TV picture

### To adjust the TV picture:

- 1 Press **MENU**. The on-screen menu opens with the **PICTURE** menu displayed.

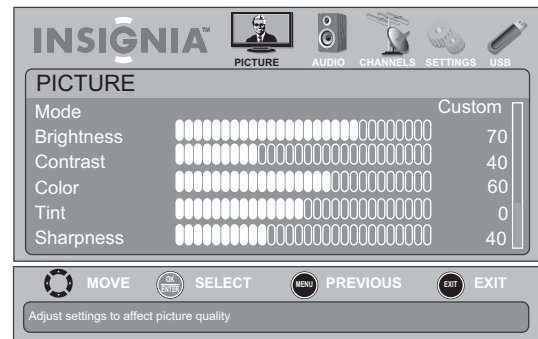

- 2 Press **▼** or **OK/ENTER** to access the menu.

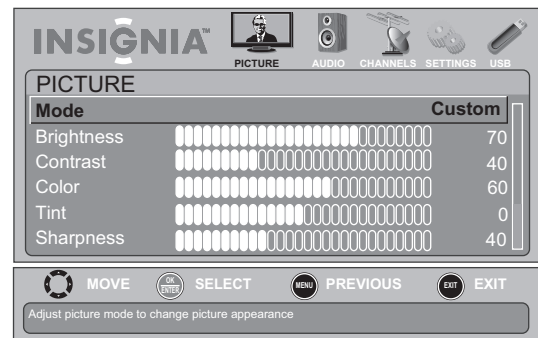

Press **▼** to view additional options.

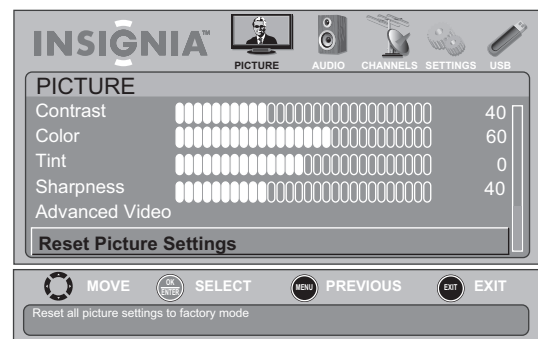

- 3 Press **▲** or **▼** to highlight an option, then press **OK/ENTER** to access the option. You can select:
  - **Mode**—Selects the picture mode. You can select:
    - **Vivid** (a bright and vivid picture)
    - **Standard** (a standard picture)
    - **Energy Savings** (the backlight brightness is decreased)
    - **Theater** (a finely detailed picture)

- **Sports** (a dynamic picture)
- **Custom** (customized picture).

**Note**

You can also press **PICT** to select the picture mode.

- **Brightness**—Adjusts the brightness of dark areas of the picture.
- **Contrast**—Adjusts the white level of the picture.
- **Color**—Adjusts the color intensity of the picture.
- **Tint**—Adjusts the image tint.
- **Sharpness**—Adjust the sharpness.
- **Advanced Video**—Opens the *PICTURE-Advanced Video* menu where you can adjust additional video options.

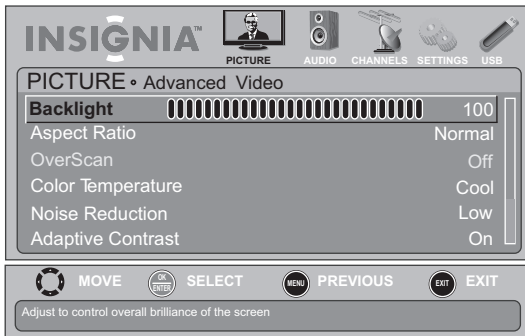

- **Backlight**—Sets the overall brilliance of the screen.
- **Aspect Ratio**—Selects the aspect ratio of the picture. You can select **Normal** (selects the correct aspect ratio to match the source image), **Wide** (shows a full-screen picture), **Zoom** (enlarges the picture but may crop the top and bottom), **Cinema** (stretches the picture at the edges, but maintains a good aspect ratio at the center of the screen), or **Auto** (select the correct aspect ratio automatically) if **Auto Zoom** in the *CHANNEL* menu is set to **On**. When **Auto Zoom** in the *CHANNEL* menu is set to **Off**, only **Normal**, **Wide**, **Zoom**, or **Cinema** can be selected.

**Note**

You can also press **ZOOM** to select the aspect ratio.

- **OverScan**—Adjusts the picture's display range. You can select **On** or **Off**.
- **Color Temperature**—Selects the color temperature. You can select **Cool** (to enhance the blues), **Normal**, or **Warm** (to enhance the reds).
- **Noise Reduction**—Selects the noise reduction mode to reduce picture noise (snow). You can select **Low**, **Middle**, **High**, or **Off**.
- **Adaptive Contrast**—Automatically adjusts picture detail and brightness. You can select **On** or **Off**.
- **Dynamic Contrast Ratio**—Enhances the contrast ratio between light and dark areas of the picture. You can select **On** or **Off**.

- **Reset Picture Settings**—Reset all picture settings to factory mode.
- 4 Press **◀** or **▶** to adjust the option, or press **▲** or **▼** to select a setting.
  - 5 Press **MENU** to return to the previous menu, or press **EXIT** to close the menu.

## Adjusting the computer image

### To adjust the computer image:

- 1 Make sure that your TV is in VGA mode. For more information, see "Selecting the video input source" on page 21.
- 2 Press **MENU**. The on-screen menu opens.

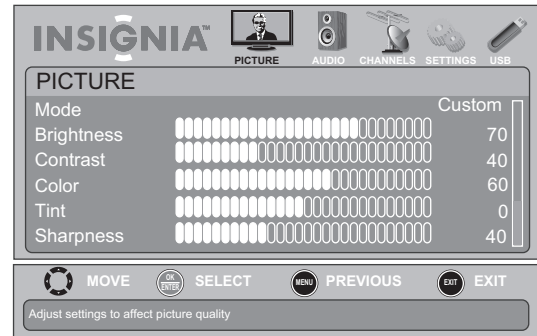

- 3 Press **◀** or **▶** to highlight **SETTINGS**, then press **▼** or **OK/ENTER**. The *SETTINGS* menu opens.



- 4 Press **▲** or **▼** to highlight **Computer Settings**, then press **OK/ENTER**. The *SETTINGS-Computer Settings* menu opens.

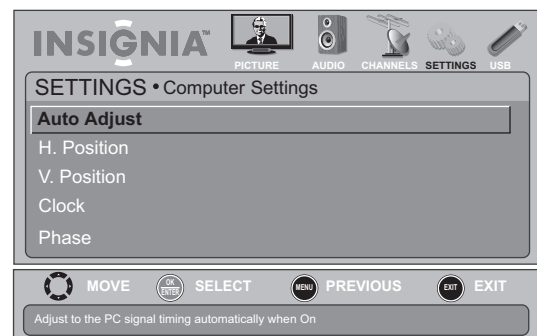

- 5 Press **▲** or **▼** to highlight an option, then press **OK/ENTER** to access the option. You can select:
  - **Auto Adjust**—Automatically adjusts the image settings such as position and phase.
  - **H. Position**—Moves the image right or left.

- **V. Position**—Moves the image up or down.
  - **Clock**—Adjusts the sample frequency.
  - **Phase**—Adjusts the focus of stable images.
- 6 Press ◀ or ▶ to adjust the option, or press ▲ or ▼ to select a setting.
  - 7 Press **MENU** to return to the previous menu, or press **EXIT** to close the menu.

- **Balance**—Adjusts the balance between the left and right audio channels.

#### Note

You can quickly adjust the treble or bass using the remote control. Press **AUDIO** repeatedly to select **Treble** or **Bass**, then press ◀ or ▶ to adjust the level.

- **Advanced Audio**—Opens the *AUDIO-Advanced Audio* menu where you can adjust additional audio options.

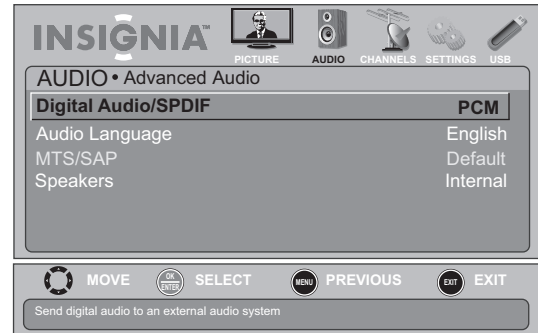

- **Digital Audio/SPDIF**—Sends digital audio to an external audio system. You can select **PCM** (to select to output audio in 2-channel stereo), or **RAW** (to pass through the original digital audio sound).
  - **Audio Language**—(Digital channels only) Selects an alternate audio language, if available.
  - **MTS Audio**—(Analog channels only) Selects the audio mode. You can select:
    - **MONO**—Select this option if there is noise or static on weak stereo broadcasts.
    - **STEREO**—Select this option for programs broadcast in stereo.
    - **SAP**—Select this option to listen to a secondary audio program, if available.
  - **Speakers**—Selects the internal speakers or external speakers (line out).
  - **Reset Audio Settings**—Reset all audio settings to factory defaults.
- 4 Press ◀ or ▶ to adjust the option, or press ▲ or ▼ to select a setting.
  - 5 Press **MENU** to return to the previous menu, or press **EXIT** to close the menu.

## Adjusting the sound

#### Note

Unless otherwise noted, all tasks in this section are based on using the remote control.

### Adjusting sound settings

#### To adjust sound settings:

- 1 Press **MENU**. The on-screen menu opens.

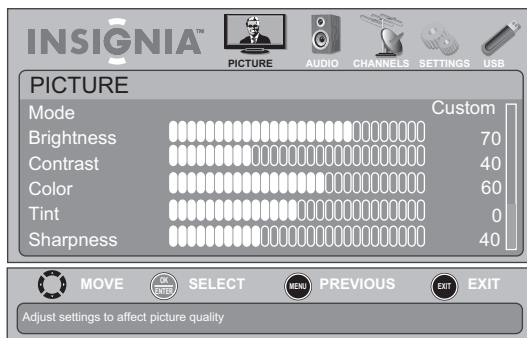

- 2 Press ◀ or ▶ to highlight **AUDIO**, then press ▼ or **OK/ENTER**. The *AUDIO* menu opens.

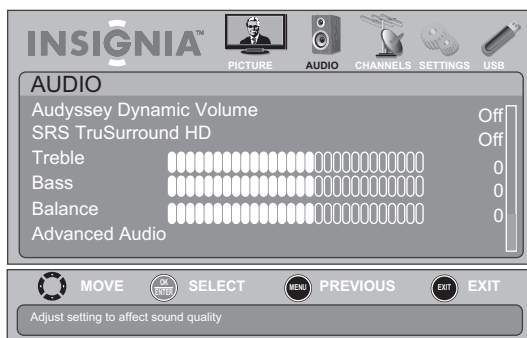

- 3 Press ▲ or ▼ to highlight an option, then press **OK/ENTER** to access the option. You can select:

- **Audyssey Dynamic Volume**—Selects the Audyssey mode. You can select **Light**, **Medium**, **Heavy**, or **Off**. When the Audyssey mode is set to **Light**, **Medium**, or **Heavy**, your TV automatically adjusts the volume to keep the volume level consistent.
- **SRS TruSurround HD**—Restores the spatial cues that are present in a live listening environment and processes audio to provide a natural 3D sound field. When Audyssey is set to **Light**, **Medium**, or **Heavy**, this option can be selected.
- **Treble**—Adjusts the high sounds.
- **Bass**—Adjusts the low sounds.

### Selecting the audio mode

#### To select the audio mode for an analog channel:

- See "Adjusting sound settings" on page 25 to select the audio mode using the on-screen menu.

## Playing TV audio only

You can turn off the picture on your TV and listen to the program audio only.

### To play TV audio only:

- 1 Press **MENU**. The on-screen menu opens.

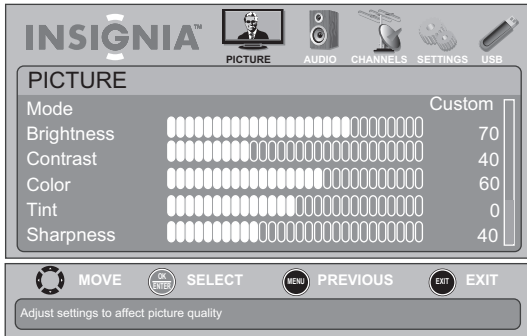

- 2 Press **◀** or **▶** to highlight **CHANNELS**, then press **▼** or **OK/ENTER**. The **CHANNELS** menu opens.



- 3 Press **▲** or **▼** to highlight **Audio Only**, then press **OK/ENTER**.
- 4 Press **▲** or **▼** to select **On**.
- 5 Press **MENU** to return to the previous menu, or press **EXIT** to close the menu.

### Notes

- **Audio Only** works only when the input source is TV and your TV is receiving a broadcast signal.
- To exit audio only mode, press any button. When you exit audio only mode, the **Audio Only** option is automatically reset to **Off**.

## Changing channel settings

### Note

Unless otherwise noted, all tasks in this section are based on using the remote control.

### Automatically scanning for channels

When you scan for channels, your TV searches for channels with signals and stores the channel information in the channel list. When you press **CH ▲/CH ▼**, your TV goes to the next or previous channel in the channel list.

If the TV signal source changes, for example you change from an outdoor antenna to cable TV (no box), you need to scan for channels.

### To automatically scan for channels:

- 1 Press **MENU**. The on-screen menu opens.

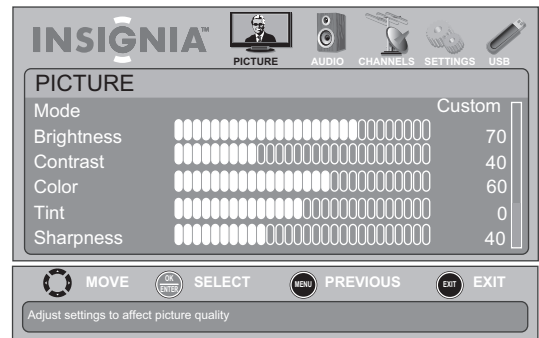

- 2 Press **◀** or **▶** to highlight **CHANNELS**, then press **▼** or **OK/ENTER**. The **CHANNELS** menu opens.

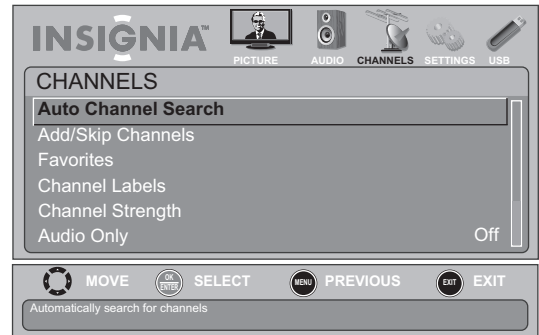

- 3 Press **▲** or **▼** to highlight **Auto Channel Search**, then press **OK/ENTER**. The **CHANNELS-Auto Channel Search** screen opens.

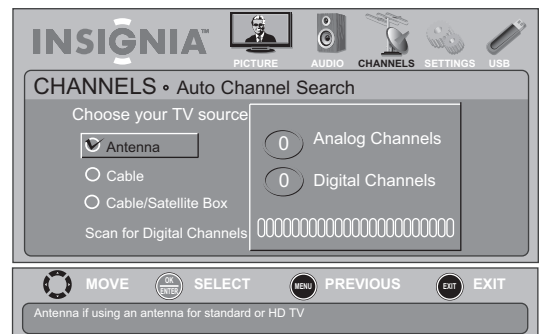

- 4 Press **▲** or **▼** to highlight **Antenna, Cable,** or **Cable/Satellite Box**, then press **OK/ENTER**.
  - If you are using an antenna for a standard or HD TV signal, select **Antenna**.
  - If your cable is connected directly to the TV (using no tuner box), select **Cable**.
  - If your cable is connected to your TV through a tuner box, select **Cable/Satellite Box**.

If you selected **Antenna** or **Cable**, your TV searches automatically for available channels in your area and stores the channel information in the channel list. This may take several minutes. While searching, the TV displays a progress report.

**Or,**

If you selected **Cable/Satellite Box**, the channel search is not necessary.

**Note**

You can press **EXIT** to stop the auto channel search, but you will need to run the auto channel search again to create a channel list.

### Hiding channels

You can hide channels in the channel list. When you press **CH ▲/CH ▼**, your TV will skip the hidden channels. You can still tune to a hidden channel by pressing the number buttons for the channel.

**To hide channels:**

- 1 Press **MENU**. The on-screen menu opens.

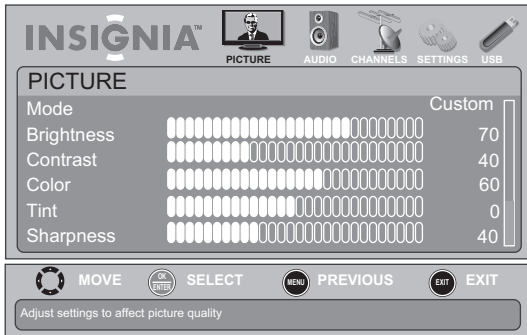

- 2 Press **◀** or **▶** to highlight **CHANNELS**, then press **▼** or **OK/ENTER**. The **CHANNELS** menu opens.



- 3 Press **▲** or **▼** to highlight **Add/Skip Channels**, then press **OK/ENTER**. The **CHANNELS-Add/Skip Channels** screen opens.



- 4 Press **▲ ▼ ◀ ▶** to highlight the channel you want to hide, then press **OK/ENTER**. The check mark disappears.

**Notes**

- A channel with a check mark is not hidden. A channel with no check mark is hidden.
- If the list has more than one page, press **▲** or **▼** to scroll through the pages.

- 5 Press **MENU** to return to the previous menu, or press **EXIT** to close the menu.

### Setting up a favorite channel list

You can create a favorite channel list so you can quickly browse through your favorite channels by pressing **FAVORITE**, then selecting a channel from the favorite channel list.

**To set up a favorite channel list:**

- 1 Press **MENU**. The on-screen menu opens.

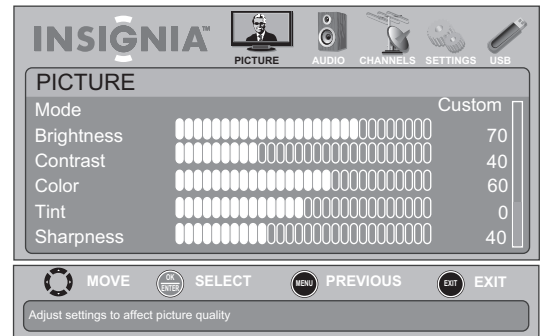

- 2 Press **◀** or **▶** to highlight **CHANNELS**, then press **▼** or **OK/ENTER**. The **CHANNELS** menu opens.



- Press **▲** or **▼** to highlight **Favorites**, then press **OK/ENTER**. The *CHANNELS-Favorites* screen opens.



- Press **▲**, **▼**, **◀** or **▶** to highlight the channel you want to add to the favorites list, then press **OK/ENTER**. A check mark appears next to the channel.

#### Notes

- To remove a channel from the favorites list, highlight the channel, then press **OK/ENTER**. The check mark disappears and the channel is removed from the list.
- If the list has more than one page, press **▲** or **▼** to scroll through the pages.

- Press **MENU** to return to the previous menu, or press **EXIT** to close the menu.

## Viewing a favorite channel

### To view a favorite channel:

- Press **FAV** on your remote control. The favorite channel list opens.
- Press **▲** or **▼** to highlight a channel, then press **OK/ENTER**.

## Adding or changing a channel label

If a channel is not already labeled, you can label the channel to make it easier to identify. You can also relabel a channel that is already labeled.

### To add or change a channel label:

- Press **MENU**. The on-screen menu opens.

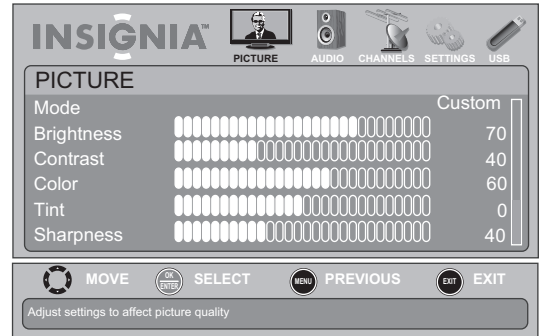

- Press **◀** or **▶** to highlight **CHANNELS**, then press **▼** or **OK/ENTER**. The *CHANNELS* menu opens.

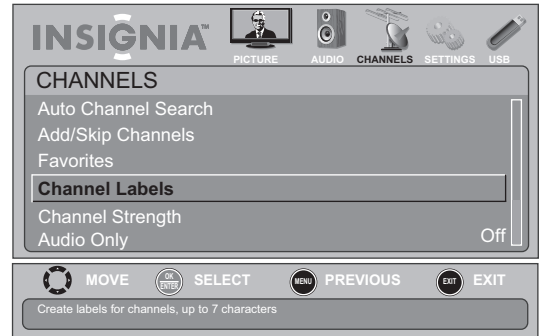

- Press **▲** or **▼** to highlight **Channel Labels**, then press **OK/ENTER**. The *CHANNELS-Channel Labels* screen opens with the channel number field highlighted.

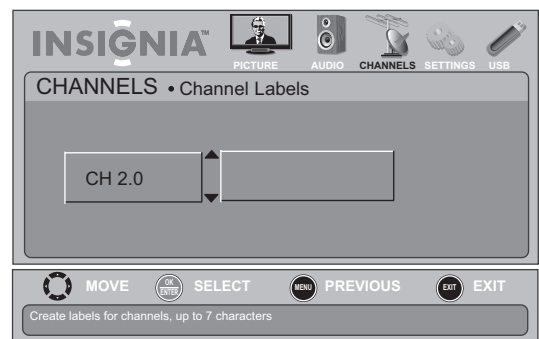



- Press **▲** or **▼** to select the channel you want to label, then press **▶** to move to the channel label field.



- Press **▲** **▼** **◀** or **▶** to highlight a character, then press **OK/ENTER**. Repeat this step to enter additional characters. You can enter as many as seven characters. If you need to delete a character, highlight **←**, then press **OK/ENTER**.
- When you have completed the label, press **MENU**.
- Press **EXIT** to close the menu.

### Checking the digital signal strength

You can check the digital signal strength to determine if you need to adjust your antenna or digital cable input. The higher the signal strength, the less likely you are to experience picture degradation.

#### To check the digital signal strength:

- Press **MENU**. The on-screen menu opens.

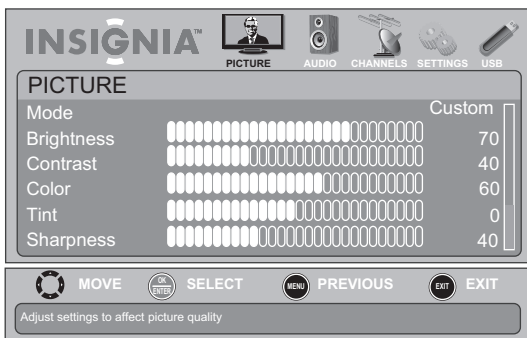

- Press **◀** or **▶** to highlight **CHANNELS**, then press **▼** or **OK/ENTER**. The **CHANNELS** menu opens.

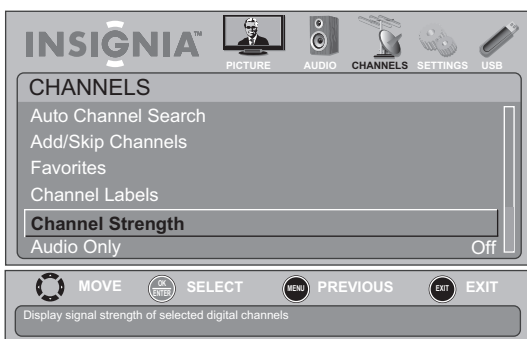

- Press **▲** or **▼** to highlight **Channel Strength**, then press **OK/ENTER**. The **Channel Strength** screen opens showing the signal strength meter.

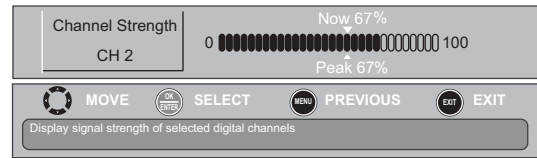

- Press **MENU** to return to the previous menu, or press **EXIT** to close the menu.

## Setting parental controls

#### Note

Unless otherwise noted, all tasks in this section are based on using the remote control.

### Setting or changing the password

Parental controls let you prevent your children from watching inappropriate material on TV. When set, parental controls read the rating of the program (with some exceptions, such as news and sports) and deny access to programs that exceed the ratings level you select. To watch programs that exceed the selected rating, you must enter a password.

#### To set or change the password:

- Press **MENU**. The on-screen menu opens.

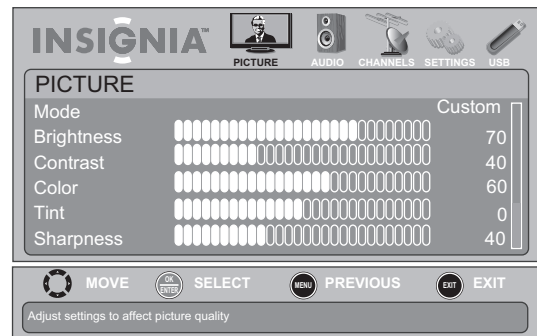

- Press **◀** or **▶** to highlight **SETTINGS**, then press **▼** or **OK/ENTER**. The **SETTINGS** menu opens with **Parental Controls** highlighted.



- 3 Press **OK/ENTER**. The *Enter Password* screen opens.



- 4 Press the number buttons to enter the four-digit password. The default password is **0000**. You should change the password to a number you can remember. The *Parental Controls* menu opens.



- 5 Press **▲** or **▼** to highlight **Change Password**, then press **OK/ENTER**. The password entry screen opens.
- 6 Press the number buttons to enter a password, then enter the password again. The *Parental Controls* menu opens again.

**Note**  
If you forget your password, enter **9999**.

- 7 Press **MENU** to return to the previous menu, or press **EXIT** to close the menu.

## Locking control buttons

When the button lock is turned **On**, the buttons on the front of your TV are locked and you can only operate your TV using the remote control.

### To lock control buttons:

- 1 Press **MENU**. The on-screen menu opens.

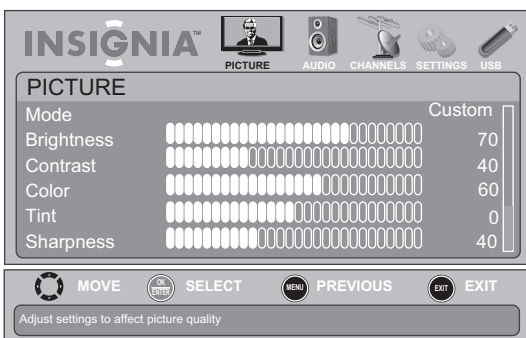

- 2 Press **◀** or **▶** to highlight **SETTINGS**, then press **▼** or **OK/ENTER**. The *SETTINGS* menu opens with **Parental Controls** highlighted.



- 3 Press **OK/ENTER**. The *Enter Password* screen opens.



- 4 Press the number buttons to enter the four-digit password. The *SETTINGS-Parental Controls* menu opens with **Button Lock** highlighted.



- 5 Press **OK/ENTER**.
- 6 Press **▲** or **▼** to select **On** (locks the buttons) or **Off** (unlocks the buttons).
- 7 Press **MENU** to return to the previous menu, or press **EXIT** to close the menu.

**Blocking unrated TV**

**To block unrated TV:**

- 1 Press **MENU**. The on-screen menu opens.

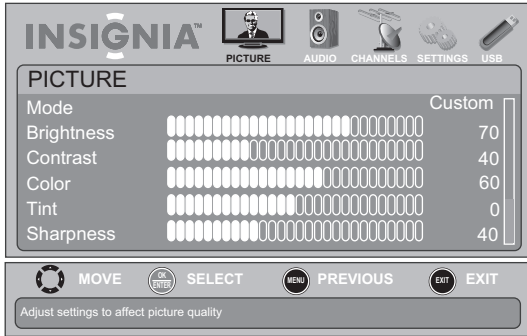

- 2 Press **◀** or **▶** to highlight **SETTINGS**, then press **▼** or **OK/ENTER**. The **SETTINGS** menu opens with **Parental Controls** highlighted.



- 3 Press **OK/ENTER**. The *Enter Password* screen opens.

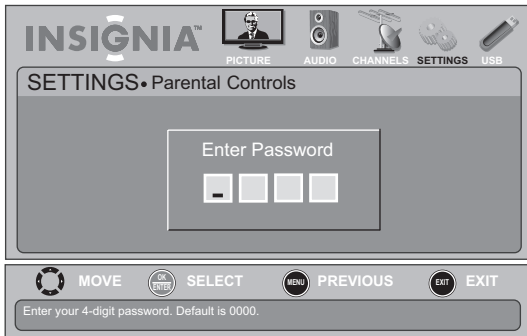

- 4 Press the number buttons to enter the four-digit password. The **SETTINGS-Parental Controls** menu opens.

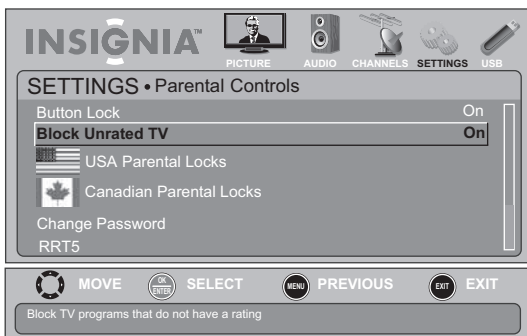

- 5 Press **▲** or **▼** to highlight **Block Unrated TV**, then press **OK/ENTER**.
- 6 Press **▲** or **▼** to select **On** (to block unrated TV) or **Off** (to unblock unrated TV).
- 7 Press **MENU** to return to the previous menu, or press **EXIT** to close the menu.

**Setting parental control levels**

You can set parental controls for the U.S. and Canada.

The following task shows how to set controls for U.S. TV ratings. You use similar steps for setting U.S. movie and Canadian TV ratings.

**To set parental control levels:**

- 1 Press **MENU**. The on-screen menu opens.

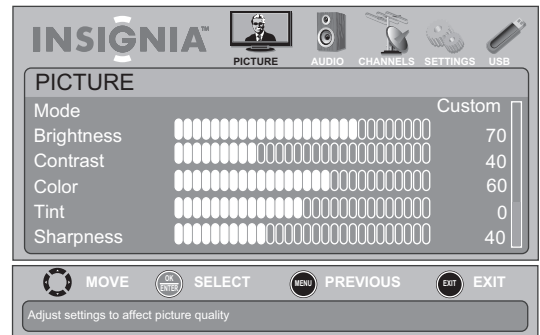

- 2 Press **◀** or **▶** to highlight **SETTINGS**, then press **▼** or **OK/ENTER**. The **SETTINGS** menu opens with **Parental Controls** highlighted.



- 3 Press **OK/ENTER**. The *Enter Password* screen opens.



- 4 Press the number buttons to enter the four-digit password. The **SETTINGS-Parental Controls** menu opens.



- 5 Press **▲** or **▼** to highlight **USA Parental Locks**, then press **OK/ENTER**. (To set Canadian ratings, select **Canadian Parental Locks**.)

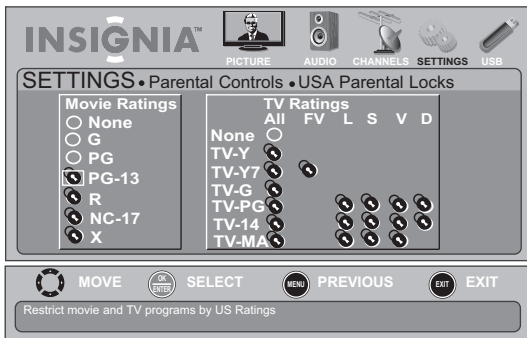

- 6 Press **◀** or **▶** to highlight **Movie Ratings** (**English Rating** for Canadian), then press **▲** or **▼** to select a rating.

**Or,**

Press **◀** or **▶** to highlight **TV Ratings** (or **French Rating** for Canadian), then press **▲** **▼** **◀** or **▶** to select the rating.

**Note**

When you block a rating, that rating and all higher ratings are blocked.

- 7 Press **OK/ENTER** to confirm. A lock symbol appears when a rating is blocked.

- 8 Press **MENU** to return to the previous menu, or press **EXIT** to close the menu.

**U.S. TV ratings**

NONE	Not rated
TV-Y	All children
TV-Y7	Children over seven years of age
TV-G	General audiences
TV-PG	Parental guidance suggested
TV-14	Parents strongly cautioned
TV-MA	Mature audiences only

Some of the age-based TV Parental Guidelines ratings also have content-based ratings.

**U.S. TV content ratings**

All	All ratings are blocked
FV	Fantasy violence
L	Adult language
S	Sexual situations
V	Violence
D	Sexually suggestive dialog

**U.S. movie (MPAA) ratings**

None	Movie not rated
G	General audiences
PG	Parental guidance suggested
PG-13	Suitable for children 13 and older
R	Parental guidance suggested for children under 17
NC-17	Not suitable for children under 17
X	Adults only

**Canadian English ratings**

E	Exempt programming
C	Children
C8+	Children over 8 years old
G	General audiences
PG	Parental guidance
14+	Over 14 years old
18+	Adult programming

**Canadian French ratings**

E	Exempt programming
G	General audiences
8ans+	Over 8 years old
13ans+	Over 13 years old
16ans+	Over 16 years old
18ans+	Adult programming

**Downloading rating information**

You can download rating information to use when setting parental controls.

**To download rating information:**

- 1 Press **MENU**. The on-screen menu opens.

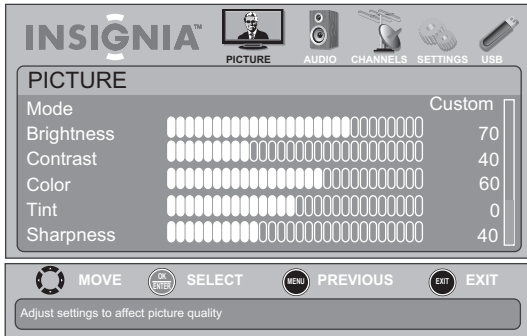

- 2 Press **◀** or **▶** to highlight **SETTINGS**, then press **▼** or **OK/ENTER**. The *SETTINGS* menu opens with **Parental Controls** highlighted.



- 3 Press **OK/ENTER**. The *Enter Password* screen opens.

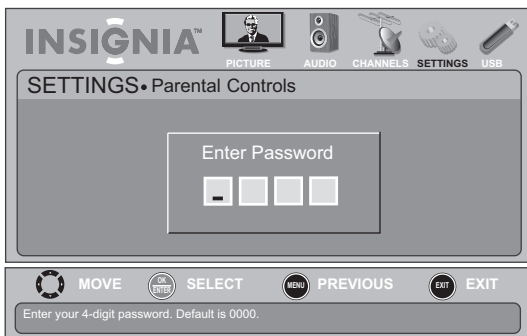

- 4 Press the number buttons to enter the four-digit password. The *SETTINGS-Parental Controls* menu opens.



- 5 Press **▲** or **▼** to highlight **RRT5**, then press **OK/ENTER**.

If the program is broadcast with RRT5 rating information, the information is downloaded automatically and can be used for parental controls.

- 6 To reset RRT information to factory mode, press **▲** or **▼** to highlight **Reset RRT**, then press **OK/ENTER**. A box opens. Follow the on-screen instructions.
- 7 Press **MENU** to return to the previous menu, or press **EXIT** to close the menu.

**Using closed captioning**

**Note**

Unless otherwise noted, all tasks in this section are based on using the remote control.

**Turning closed captioning on or off**

**To turn closed captioning on or off:**

- 1 Press **MENU**. The on-screen menu opens.

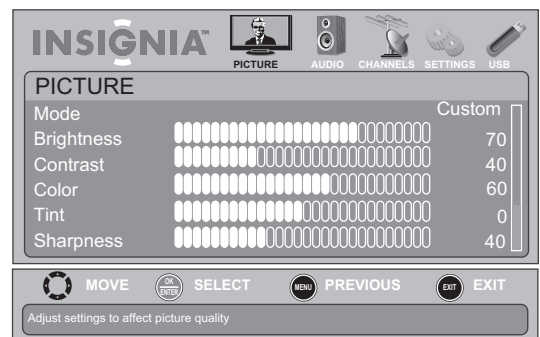

- 2 Press **◀** or **▶** to highlight **SETTINGS**, then press **▼** or **OK/ENTER**. The *SETTINGS* menu opens.



- 2 Press **◀** or **▶** to highlight **SETTINGS**, then press **▼** or **OK/ENTER**. The *SETTINGS* menu opens.



- 3 Press **▲** or **▼** to highlight **Closed Caption**, then press **OK/ENTER**. The *SETTINGS-Closed Caption* menu opens.



- 3 Press **▲** or **▼** to highlight **Closed Caption**, then press **OK/ENTER**. The *SETTINGS-Closed Caption* menu opens.

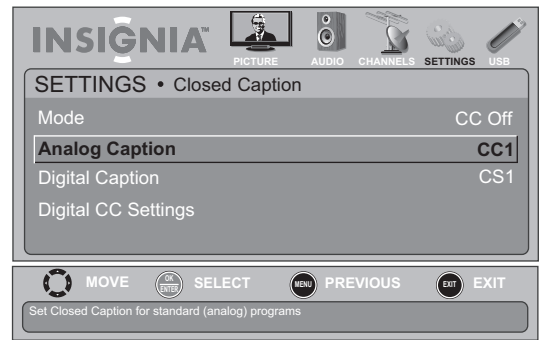

- 4 Press **▲** or **▼** to highlight **Mode**, then press **OK/ENTER**. A menu opens.
- 5 Press **▲** or **▼** to select **CC Off** (turns off closed captioning), **CC On** (turns on closed captioning), or **CC on Mute** (turns on closed captioning when the sound is muted).
- 6 Press **MENU** to return to the previous menu, or press **EXIT** to close the menu.

**Note**  
You can also press **CC** to turn closed captioning on or off.

- 4 Press **▲** or **▼** to highlight **Analog Caption**, then press **OK/ENTER**. A menu opens.
- 5 Press **▲** or **▼** to select an analog caption setting. You can select:
  - **CC1** through **CC4**—Closed captioning appears in a small banner across the bottom of the screen. **CC1** is usually the “printed” version of the audio. **CC2** through **CC4** display content provided by the broadcaster.
  - **Text1** through **Text4**—Closed captioning that covers half or all of the screen. **Text1** through **Text4** display content provided by the broadcaster.
- 6 Press **MENU** to return to the previous menu, or press **EXIT** to close the menu.

## Selecting the analog closed captioning mode

To select the analog closed captioning mode:

- 1 Press **MENU**. The on-screen menu opens.

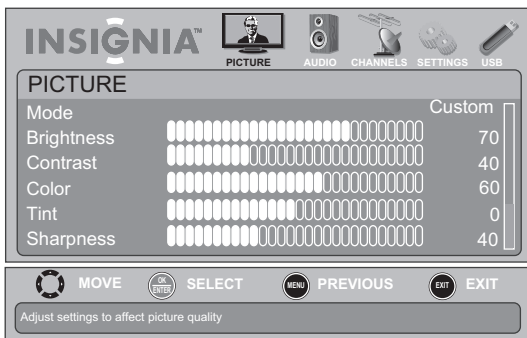

## Customizing digital closed captioning styles

To customize digital closed captioning styles:

- 1 Press **MENU**. The on-screen menu opens.

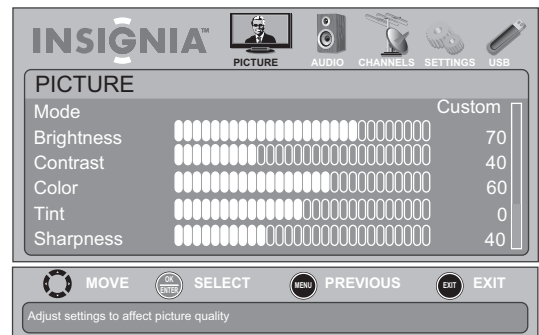

- Press **◀** or **▶** to highlight **SETTINGS**, then press **▼** or **OK/ENTER**. The *SETTINGS* menu opens.



- Press **▲** or **▼** to highlight **Closed Caption**, then press **OK/ENTER**. The *SETTINGS-Closed Caption* menu opens.

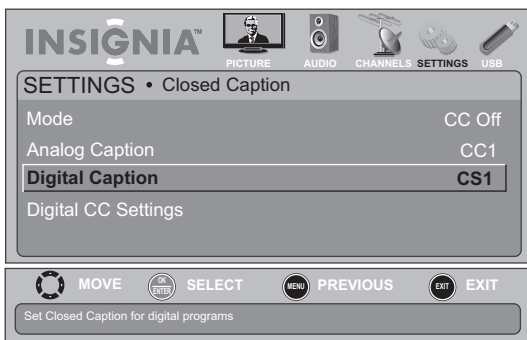

- Press **▲** or **▼** to highlight **Digital Caption**, then press **OK/ENTER**. A menu opens.
- Press **▲** or **▼** to highlight a digital caption setting, then press **OK/ENTER**. You can select **CS1** through **CS6**.
- Press **MENU** to return to the previous menu, press **▲** or **▼** to highlight **Digital CC Settings**, then press **OK/ENTER**. The *Digital CC Settings* menu opens with **Style** highlighted.

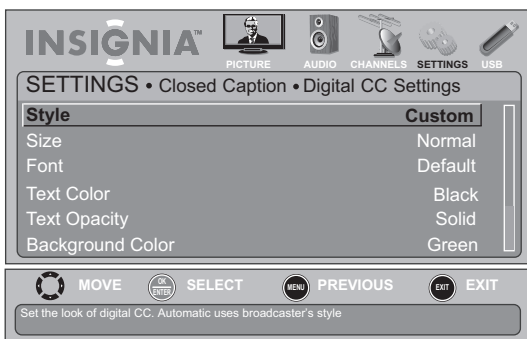

- Press **OK/ENTER**, then press **◀** or **▶** to select **Custom**.
- Press **▲** or **▼** to highlight an option, then press **OK/ENTER**. You can select:
  - Size**—Selects the font size.
  - Font**—Selects the font style.
  - Text Color**—Selects the color for the words.
  - Text Opacity**—Selects the opacity level for the words.

- Background Color**—Selects the color for the background.
  - Background Opacity**—Selects the opacity level for the background.
  - Edge Settings**—Set the **Edge Effect** (to select the edge style) and **Edge Color** (to select the edge color).
- Press **MENU** to return to the previous menu, or press **EXIT** to close the menu.

## Adjusting time settings

### Note

Unless otherwise noted, all tasks in this section are based on using the remote control.

### Setting the time

#### To set the clock:

- Press **MENU**. The on-screen menu opens.

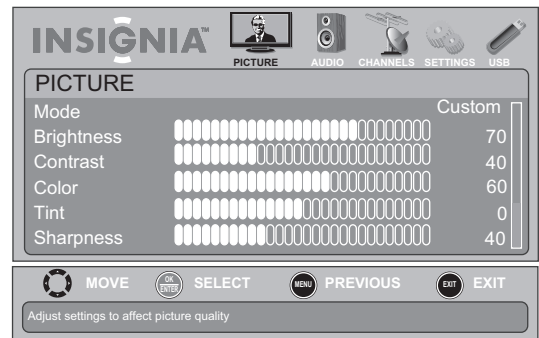

- Press **◀** or **▶** to highlight **SETTINGS**, then press **▼** or **OK/ENTER**. The *SETTINGS* menu opens.



- Press **▲** or **▼** to highlight **Time**, then press **OK/ENTER**. The *SETTINGS-Time* menu opens.



- Press **▲** or **▼** to highlight **Date/Time**, then press **OK/ENTER**. The *SETTINGS-Time-Date/Time* menu opens.

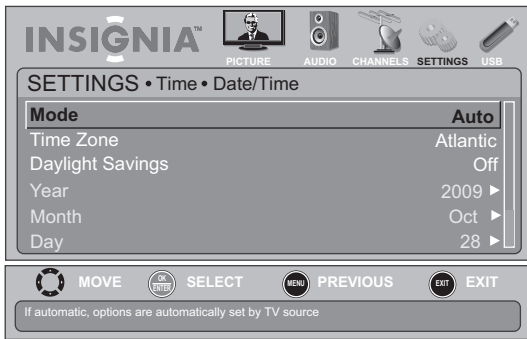

- Press **▲** or **▼** to highlight **Mode**, then press **OK/ENTER**. A menu opens.
- Press **▲** or **▼** to highlight **Custom** (to set the options manually) or **Auto** (the options are automatically set by the TV signal source).
- Press **OK/ENTER** to close the menu.
- Press **▲** or **▼** to highlight **Time Zone**, then press **OK/ENTER**. The *Time-Time Zone* menu opens.
- Press **▲** or **▼** to select your time zone. You can select **Eastern, Central, Mountain, Pacific, Alaska, Hawaii, Atlantic, or Newfoundland**.
- Press **OK/ENTER** to close the menu.
- If your viewing area observes daylight savings time, press **▲** or **▼** to highlight **Daylight Savings**, then press **OK/ENTER**.
- Press **▲** or **▼** to select **On**, then press **OK/ENTER** to close the menu.
- If you selected **Custom** for **Mode**:
  - Press **▲** or **▼** to highlight **Year, Month, or Date**, then press **◀** or **▶** to adjust the setting.
  - Press **▲** or **▼** to highlight **Time**, press **◀** or **▶** to move to the hour, minute, or AM/PM field, then press **▲** or **▼** to adjust the setting.
- Press **MENU** to return to the previous menu, or press **EXIT** to close the menu.

## Setting the sleep timer

You can specify the amount of time before your TV automatically turns off.

### To set the sleep timer:

- Press **MENU**. The on-screen menu opens.

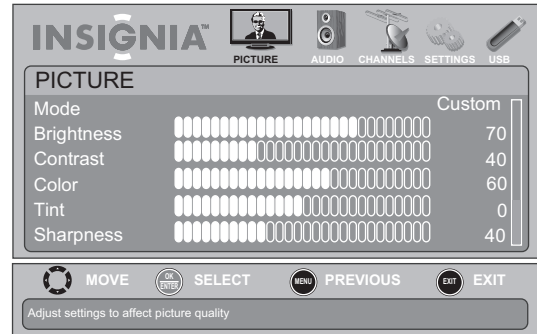

- Press **◀** or **▶** to highlight **SETTINGS**, then press **▼** or **OK/ENTER**. The *SETTINGS* menu opens.



- Press **▲** or **▼** to highlight **Time**, then press **OK/ENTER**. The *SETTINGS-Time* menu opens.



- Press **▲** or **▼** to highlight **Sleep Timer**, then press **OK/ENTER**. A menu opens.
- Press **▲** or **▼** to select the amount of time before your TV turns off automatically. To turn off the sleep timer, select **Off**.
- Press **MENU** to return to the previous menu, or press **EXIT** to close the menu.

### Note

You can also press **SLEEP** to set the sleep timer.



# Adjusting menu settings

## Note

Unless otherwise noted, all tasks in this section are based on using the remote control.

## Selecting the menu language and transparency

To select the menu language and transparency:

- 1 Press **MENU**. The on-screen menu opens.

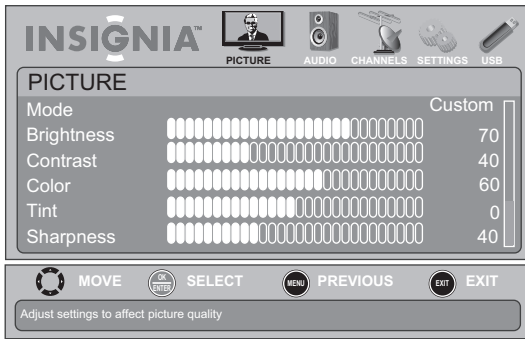

- 2 Press **◀** or **▶** to highlight **SETTINGS**, then press **▼** or **OK/ENTER**. The **SETTINGS** menu opens.



- 3 Press **▲** or **▼** to highlight **Menu Settings**, then press **OK/ENTER**. The **SETTINGS-Menu Settings** menu opens.



- 4 Press **▲** or **▼** to highlight **Language**, then press **OK/ENTER**. A language menu opens.
- 5 Press **▲** or **▼** to highlight **English**, **French**, or **Spanish**, then press **OK/ENTER** to close the menu.
- 6 Press **▲** or **▼** to highlight **Transparency**, then press **OK/ENTER**.

- 7 Press **◀** or **▶** to adjust the menu transparency.
- 8 Press **MENU** to return to the previous menu, or press **EXIT** to close the menu.

## Labeling an input source

To label an input source:

- 1 Press **MENU**. The on-screen menu opens.

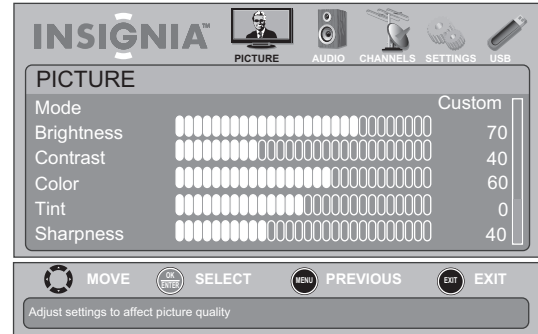

- 2 Press **◀** or **▶** to highlight **SETTINGS**, then press **▼** or **OK/ENTER**. The **SETTINGS** menu opens.



- 3 Press **▲** or **▼** to highlight **Input Labels**, then press **OK/ENTER**. The **SETTINGS-Input Labels** screen opens with the input source field highlighted.

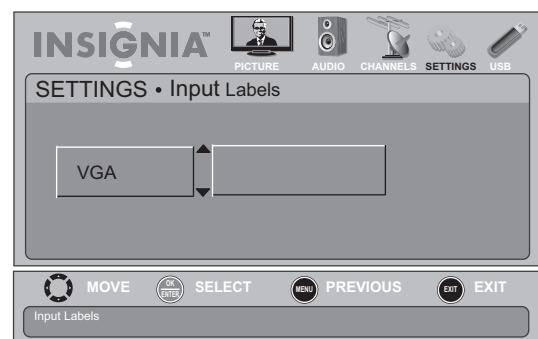

- Press **▲** or **▼** to select the input source you want to label, then press **▶** to move to the custom label field.



- Press **▲**, **▼**, **◀** or **▶** to highlight a character, then press **OK/ENTER**. Repeat this step to enter additional characters. You can enter as many as 11 characters. If you need to delete a character, highlight **←**, then press **OK/ENTER**.
- When you have completed the label, press **MENU**. The next time you press **INPUT**, your label will appear in the *Input Source* list.
- Press **EXIT** to close the menu.

## Turning Auto Input Sensor on or off

When the Input Sensor feature is turned on, your TV automatically detects which video jacks have devices connected to them. Your TV uses this information to determine what options appear on the *Input Source* list when you press **INPUT**.

### To turn Input Sensor on or off:

- Press **MENU**. The on-screen menu opens.

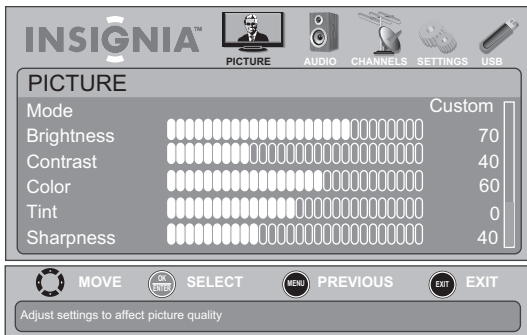

- Press **◀** or **▶** to highlight **SETTINGS**, then press **▼** or **OK/ENTER**. The *SETTINGS* menu opens.

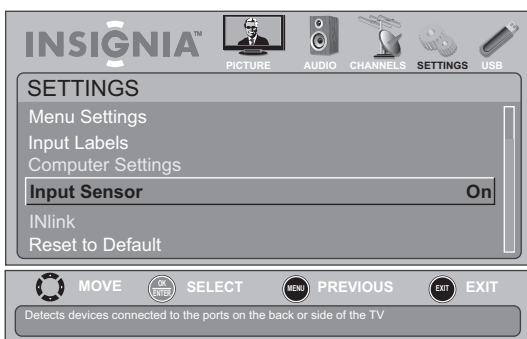

- Press **▲** or **▼** to highlight **Input Sensor**, then press **OK/ENTER**. A menu opens.
- Press **◀** or **▶** to select **On** (to activate the input sensor) or **Off** (to deactivate the input sensor).
- Press **MENU** to return to the previous menu, or press **EXIT** to close the menu.

## Using INlink

INlink lets you control HDMI CEC-compatible devices connected to the HDMI jacks on your TV using the remote control that came with your TV. To use INlink, you must set the **INlink Control** option on the *SETTINGS-INlink* menu to **On**.

### To turn INlink on or off:

- Press **MENU**. The on-screen menu opens.

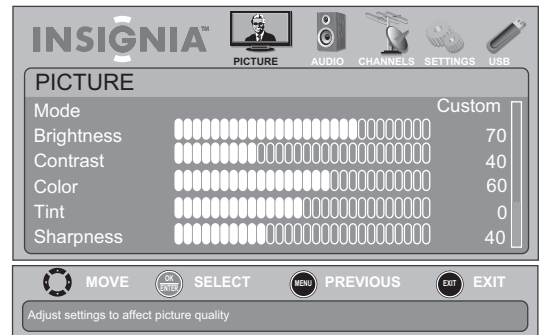

- Press **◀** or **▶** to highlight **SETTINGS**, then press **▼** or **OK/ENTER**. The *SETTINGS* menu opens.

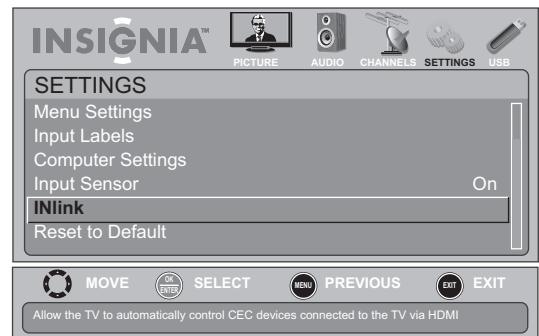

- Press **▲** or **▼** to highlight **INlink**, then press **OK/ENTER**. The *SETTINGS-INlink* menu opens.



- Press **▲** or **▼** to highlight **INlink Control**, then press **OK/ENTER**. A menu opens.

- 5 Press **▲** or **▼** to highlight **On** (to turn on the **INlink Control** option) or **Off** (to turn off the **INlink Control** option).
- 6 Press **MENU** to return to the previous menu, or press **EXIT** to close the menu.

**To turn Device Auto Power Off on or off:**

- 1 Press **MENU**. The on-screen menu opens.

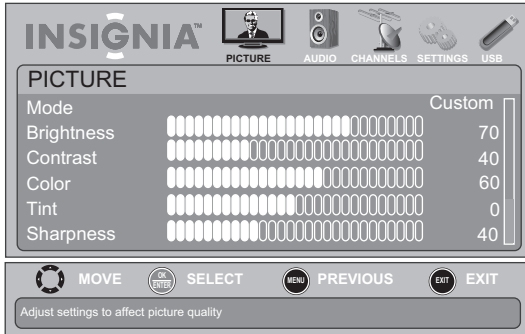

- 2 Press **◀** or **▶** to highlight **SETTINGS**, then press **▼** or **OK/ENTER**. The **SETTINGS** menu opens.

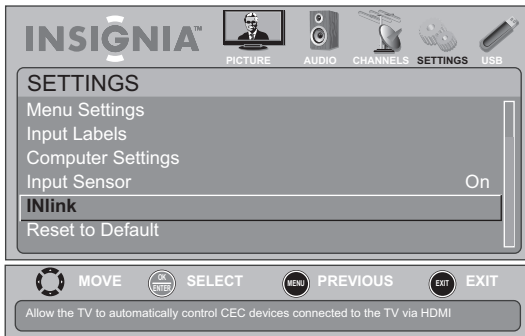

- 3 Press **▲** or **▼** to highlight **INlink**, then press **OK/ENTER**. The **SETTINGS-INlink** menu opens.

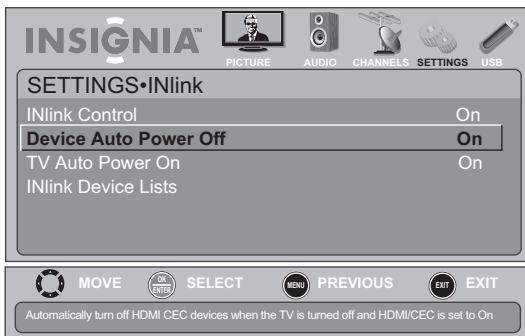

- 4 Press **▲** or **▼** to highlight **Device Auto Power Off**, then press **OK/ENTER**. A menu opens.
- 5 Press **▲** or **▼** to select **On** (turns off the connected device when you turn off your TV) or **Off** (does not turn off the connected device when you turn off your TV).
- 6 Press **MENU** to return to the previous menu, or press **EXIT** to close the menu.

**To turn TV Auto Power On on or off:**

- 1 Press **MENU**. The on-screen menu opens.

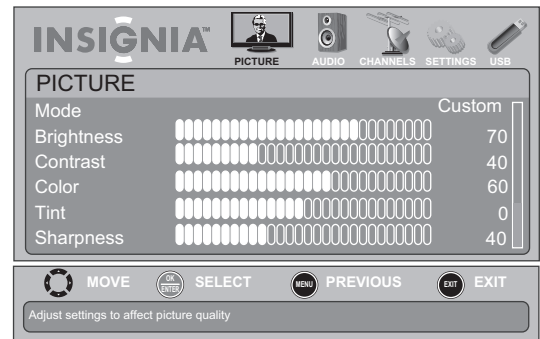

- 2 Press **◀** or **▶** to highlight **SETTINGS**, then press **▼** or **OK/ENTER**. The **SETTINGS** menu opens.

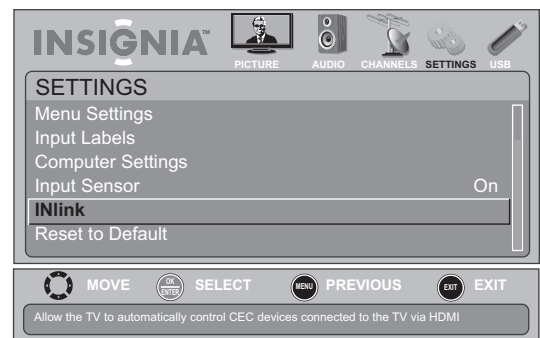

- 3 Press **▲** or **▼** to highlight **INlink**, then press **OK/ENTER**. The **SETTINGS-INlink** menu opens.



- 4 Press **▲** or **▼** to highlight **TV Auto Power On**, then press **OK/ENTER**. A menu opens.
- 5 Press **▲** or **▼** to select **On** (turns on your TV when you turn on the connected device) or **Off** (does not turn on your TV when you turn on the connected device).
- 6 Press **MENU** to return to the previous menu, or press **EXIT** to close the menu.

### To display a list of INlink-compatible devices:

- 1 Press **MENU**. The on-screen menu opens.

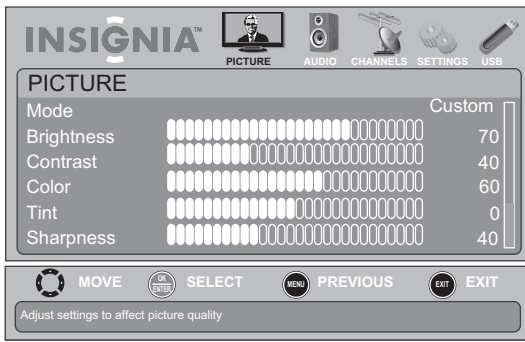

- 2 Press **◀** or **▶** to highlight **SETTINGS**, then press **▼** or **OK/ENTER**. The **SETTINGS** menu opens.

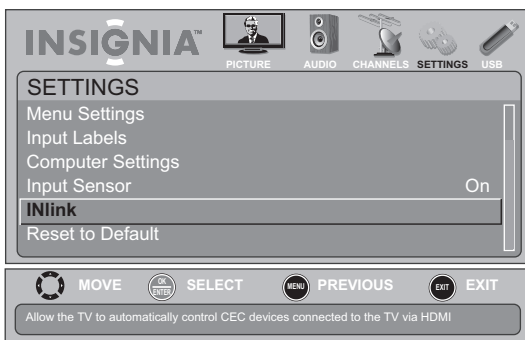

- 3 Press **▲** or **▼** to highlight **INlink**, then press **OK/ENTER**. The **SETTINGS-INlink** menu opens.



- 4 Press **▲** or **▼** to highlight **INlink Device Lists**, then press **OK/ENTER**. A list of the HDMI CEC-compatible devices you have connected appears.
- 5 Press **MENU** to return to the previous menu, or press **EXIT** to close the menu.

#### Notes

HDMI cables must be used to connect HDMI CEC-compatible devices to your TV.  
The connected device's HDMI CEC feature must be turned on.  
If you connect an HDMI device that is not HDMI CEC-compatible, the **INlink Control** option does not work.  
Depending on the connected HDMI device, the **INlink Control** option may not work.

### Restoring settings to the defaults

When you restore default settings, all the settings you have customized (except the password and parental rating) are reset.

#### To restore settings to the defaults:

- 1 Press **MENU**. The on-screen menu opens.

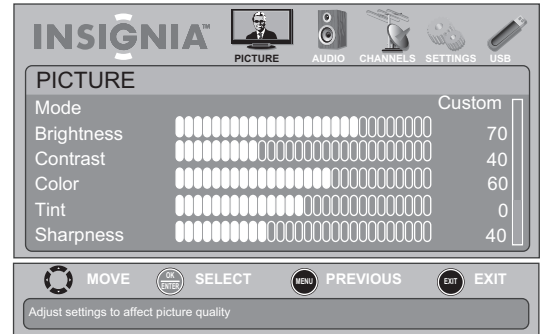

- 2 Press **◀** or **▶** to highlight **SETTINGS**, then press **▼** or **OK/ENTER**. The **SETTINGS** menu opens.



- 3 Press **▲** or **▼** to highlight **Reset to Default**, then press **OK/ENTER**. A confirmation box opens.
- 4 Press **◀** or **▶** to select **Yes** (to reset) or **No** (to not reset), then press **OK/ENTER**.
- 5 Press **MENU** to return to the previous menu, or press **EXIT** to close the menu.

## Using USB

#### Note

Unless otherwise noted, all tasks in this section are based on using the remote control.

You can connect a USB device to your TV to view compatible JPEG pictures.

#### Notes

- Never remove the USB device or turn off your TV while viewing JPEG pictures.
- We recommend that you back up the data on your USB device.
- The JPEG picture viewer only supports JPEG format images (with ".jpg" file extensions) and not all JPEG files are compatible with the TV.

## Switching to USB mode

### To switch to USB mode:

- 1 Make sure that you have connected the USB device to the USB port on the back of your TV.
- 2 Press **INPUT**. The *Input Source* list opens.
- 3 Press **▲** or **▼** to highlight **USB**, then press **OK/ENTER**.

## Browsing photos

### To browse photos:

- 1 Make sure that you have connected the USB device to the USB port on the back of your TV.
- 2 Press **MENU**. The on-screen menu opens.

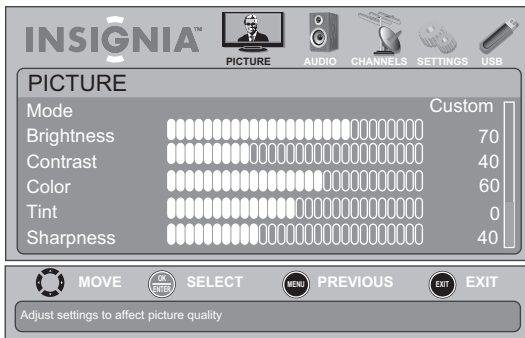

- 3 Press **◀** or **▶** to highlight **USB**, then press **▼** or **OK/ENTER**. The *PHOTO* menu opens.



- 4 Press **▲** or **▼** to highlight **Browse Photos**, then press **OK/ENTER**. The screen displays folder names and photo files stored on the USB device in a thumbnail index with the first photo or folder highlighted. A control bar appears at the bottom of the screen.

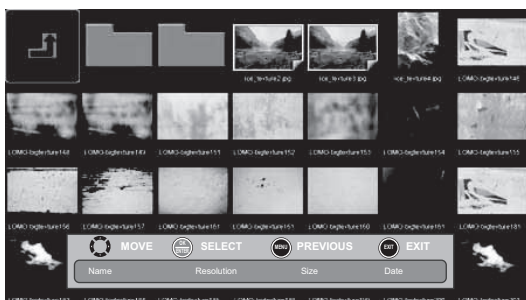

- 5 To navigate the thumbnail index screen:

- Press **▲** **▼** **◀** or **▶** to browse through the files and folders.
- Press **ENTER** to view a highlighted photo full-screen or open a highlighted folder.
- Press **MENU** to open the *USB* menu.
- Press **FAV** to add or remove a photo from the favorite photo list. A heart appears on a photo that has been added to the favorite photo list.
- Select **⏪**, then press **OK/ENTER** to go a level in the folder directory.
- Press **EXIT** to clear the the control bar.

When a photo is displayed full-screen, a control bar appears at the bottom of the photo. The control bar appears when any button is pressed, and disappears automatically if no button is used within 10 seconds. The file name, picture resolution, size, and date are displayed on the bottom of the control bar.

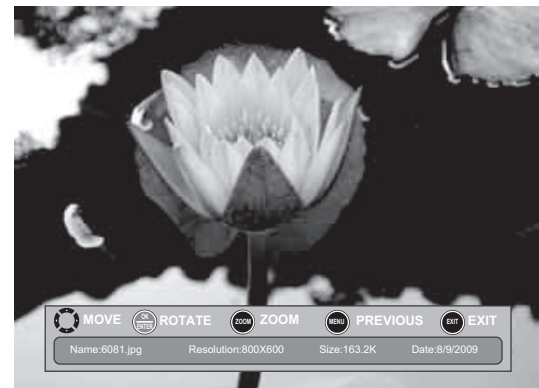

To navigate on the photo screen, press:

- **◀** or **▲** to go to the previous photo.
- **▶** or **▼** to go to the next photo.
- **ENTER** to rotate the photo clockwise.
- **ZOOM** one or more times to enlarge the image by 2x, 4x, or to fill the screen (Fill). If arrows appear in Zoom mode, you can press **◀** **▶** **▲** or **▼** to pan the photo.
- **EXIT** to return to the thumbnail index.
- **MENU** to go to the *USB* menu.

## Viewing favorite photos

After you created your favorite photo list, you can browse among your favorite photos quickly.

### To view favorite photos:

- 1 Press **MENU**. The on-screen menu opens.

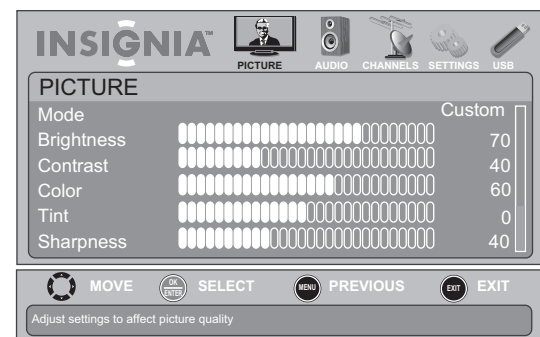

- Press **◀** or **▶** to highlight **USB**, then press **▼** or **OK/ENTER**. The **PHOTO** menu opens.

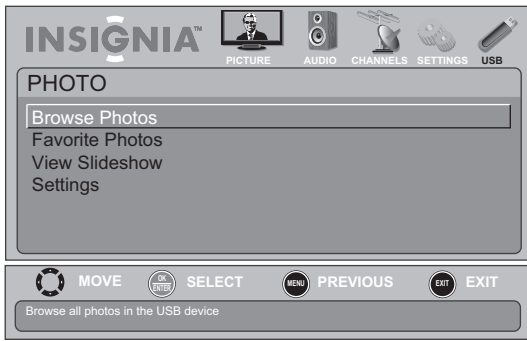

- Press **◀** or **▶** to highlight **USB**, then press **▼** or **OK/ENTER**. The **PHOTO** menu opens.



- Press **▲** or **▼** to highlight **Favorite Photos**, then press **OK/ENTER**. A thumbnail index of your favorite photos opens with a control bar at the bottom of the screen.

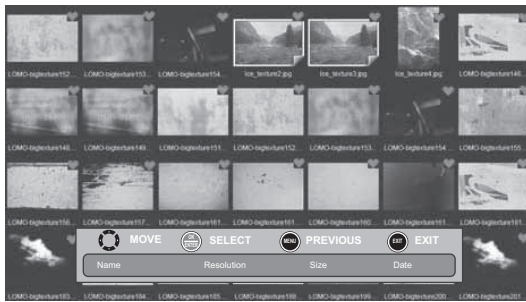

You select photos and navigate on the photo screen in the same way you do when you are browsing through photos. For more information, see "Browsing photos" on page 41.

- Press **▲** or **▼** to highlight **View Slideshow**, then press **OK/ENTER**. A slideshow starts with the first photo in the current folder.

A control bar appears at the bottom of the photo. The control bar appears when any button is pressed, and disappears automatically if no button is used within 10 seconds. The file name, picture resolution, size, and date are displayed on the bottom of the control bar.



## Viewing photos in a slideshow

You can view your photos in a slideshow.

### To view photos in a slideshow:

- Press **MENU**. The on-screen menu opens.

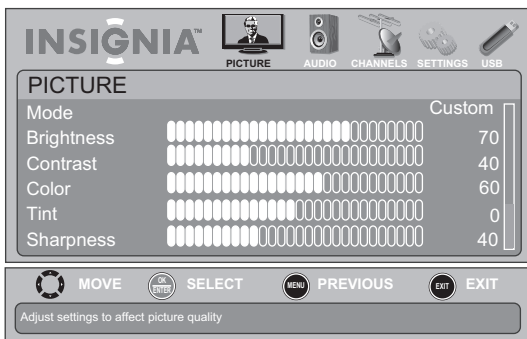

- To control in the slideshow, press:

- ENTER** to pause or start the slideshow.
- EXIT** to exit the slideshow and return to thumbnail index.
- MENU** to go to the **USB** menu.

## Customizing slideshow settings

You can customize the slideshow settings, including **Repeat**, **Shuffle**, **Speed**, and **Transition**.

### To customize slideshow settings:

- Press **MENU**. The on-screen menu opens.

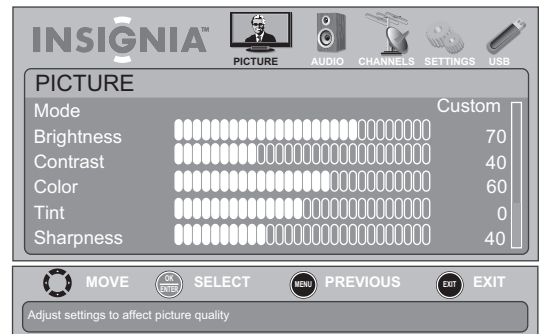

- 2 Press ◀ or ▶ to highlight **USB**, then press ▼ or **OK/ENTER**. The *PHOTO* menu opens.



- 3 Press ▲ or ▼ to highlight **Settings**, then press **OK/ENTER**. The *USB-Photo Settings* menu opens.



- 4 Press ▲ or ▼ to highlight an option, then press **OK/ENTER**. You can select:
- **Repeat**—Repeats the slideshow when it reaches the end. You can select **On** or **Off**.
  - **Shuffle**—Displays the slideshow photo in random order. You can select **On** or **Off**.
  - **Speed**—Sets the amount of time a photo is displayed before the slideshow moves to the next photo. You can select **2 Sec**, **4 Sec**, **6 Sec**, or **8 Sec**.
  - **Transition**—Selects a transition effect when moving to the next file in the slideshow. You can select **None**, **Fade to Black**, **Vertical Wipe**, **Horizontal Wipe**, or **Random**.
- 5 Press **EXIT** to close the menu.

## Maintaining

### Cautions

- Make sure that the TV is turned off and the power cord is disconnected from the power outlet before cleaning the TV.
- Never spray or pour any liquid directly onto the LCD screen or the TV cabinet.
- Never use a solvent or alcohol to clean your TV. Do not spray insecticide near your TV. Such chemicals may cause damage and discoloration to the exposed surfaces.

### Cleaning the TV cabinet

Clean the TV cabinet with a soft, dry cloth. If surfaces are extremely dirty, slightly dampened the cloth with lukewarm water.

### Cleaning the LCD screen

Clean the screen with a clean, soft, lint-free cloth. If additional cleaning is necessary, apply a small amount of non-ammonia, non-alcohol-based glass cleaner onto the cloth, then wipe the screen.

## Troubleshooting

### Caution

Do not try to repair your TV yourself. Refer all servicing to qualified service personnel.

### Note

If the problem is not solved by using these troubleshooting instructions, turn off your TV, then turn it on again.

Problem	Solution
<b>Power</b>	
No power	<ul style="list-style-type: none"> <li>• Make sure that the power cord is correctly connected to your TV and a power outlet. See "Connecting power" on page 14.</li> <li>• Unplug the power cord, wait 60 seconds, then plug the cord back in and turn on your TV.</li> </ul>
<b>General remote control</b>	
Remote control does not work	<ul style="list-style-type: none"> <li>• Make sure that there are no obstructions between the remote control and the remote control sensor on the front of your TV.</li> <li>• Clean the remote sensor on the front of your TV.</li> <li>• Bright or fluorescent lighting may interfere with the remote control signal. Turn off the light or move your TV.</li> <li>• Replace the batteries. Make sure that the + and – symbols on the batteries align with the + and – symbols in the battery compartment. See "Installing remote control batteries" on page 9.</li> </ul>
Remote control code cannot be detected by a universal remote	<ul style="list-style-type: none"> <li>• Purchase a separate learning remote control.</li> <li>• Go to <a href="http://www.insigniaproducts.com">www.insigniaproducts.com</a> for a list of remote control codes.</li> </ul>

Problem	Solution
<b>Programmed remote control functions</b>	
The LED does not blink when you press a button	<ul style="list-style-type: none"> <li>Try pressing different buttons.</li> <li>The batteries may already be drained. Replace the batteries.</li> </ul>
The LED blinks when you press a button but the device does not respond.	<ul style="list-style-type: none"> <li>Make sure the remote is aimed at your device and is not more than 40 feet (12.2 m) away.</li> </ul>
The LED blinks one long blink while in SET mode	<ul style="list-style-type: none"> <li>An entry error has occurred (for example, wrong button was pressed). Try entering the sequence again.</li> </ul>
When programming the remote control, the remote does not control devices or commands are not working correctly	<ul style="list-style-type: none"> <li>Try all listed codes for the device.</li> <li>Make sure the device operates with an infrared remote control.</li> </ul>
No volume on a device	<ul style="list-style-type: none"> <li>Refer to "Changing the volume lock" on page 11 and make sure the volume is not locked to a different mode already.</li> </ul>
Channels do not change correctly when directly entering numbers to change channels	<ul style="list-style-type: none"> <li>If the original remote control required you to press <b>ENTER</b> to change channels, press <b>OK/ENTER</b> on your TV remote control after entering the channel number.</li> </ul>
<b>Picture</b>	
No picture	<ul style="list-style-type: none"> <li>Make sure that the <b>Audio Only</b> option is set to <b>Off</b>. See "Playing TV audio only" on page 26.</li> <li>Make sure that the video cables are connected securely to the back of your TV. See "Making connections" on page 14.</li> <li>Adjust the contrast and brightness. See "Adjusting the TV picture" on page 23.</li> <li>Make sure that the correct video mode is selected. See "Selecting the video input source" on page 21.</li> <li>Make sure that the incoming signal is compatible.</li> <li>Make sure the antenna is connected correctly. See "Connecting an antenna or cable TV without a cable box" on page 14.</li> <li>Check the closed caption settings. Some TEXT modes can block the screen. See "Selecting the analog closed captioning mode" on page 34.</li> </ul>
Good sound but poor color	<ul style="list-style-type: none"> <li>Adjust the contrast, color, and brightness settings. See "Adjusting the TV picture" on page 23.</li> </ul>
Poor picture	<ul style="list-style-type: none"> <li>Make sure that the room is not too bright. Light reflecting off the screen can make the picture difficult to see.</li> <li>If an S-VHS camera or a camcorder is connected while another connected device is turned on, the picture may be poor. Turn off one or more devices.</li> </ul>
Horizontal dotted line	<ul style="list-style-type: none"> <li>Your TV may be too close to another electrical device, such as a hair dryer or neon light. Turn off the device or move your TV.</li> </ul>
"Ghost" or double image	<ul style="list-style-type: none"> <li>Obstructions, such as high-rise building or hills, may be preventing your antenna from receiving a clear signal. Using a highly directional antenna may improve the picture quality.</li> </ul>
Snowy picture or noise	<ul style="list-style-type: none"> <li>Make sure that the AV and antenna cables are connected securely.</li> </ul>

Problem	Solution
VGA picture is not stable or synchronized	<ul style="list-style-type: none"> <li>Make sure that you have selected the correct VGA mode on your computer.</li> </ul>
After images appear	<ul style="list-style-type: none"> <li>Do not display a still image, such as a logo, game, or computer image, for an extended period of time. This can cause a permanent after-image to be burned into the screen. This type of damage is not covered by your warranty.</li> </ul>
Picture has a few bright or dark spots	<ul style="list-style-type: none"> <li>A few bright or dark dots on an LCD screen is normal. It does not affect the operation of this TV.</li> </ul>
<b>Audio</b>	
Good picture but no sound	<ul style="list-style-type: none"> <li>Increase the volume.</li> <li>Make sure that the sound is not muted.</li> <li>Make sure that the correct audio mode is selected. See "Adjusting sound settings" on page 25.</li> </ul>
No output from one of the speakers	<ul style="list-style-type: none"> <li>Adjust the balance in the <i>Audio</i> menu. See "Adjusting sound settings" on page 25.</li> </ul>
<b>Other</b>	
Buttons on the front of the TV do not work	<ul style="list-style-type: none"> <li>Make sure that the <b>Button Lock</b> option is set to <b>Off</b>. See "Locking control buttons" on page 30.</li> <li>Unplug the power cord, wait a few seconds, then plug the cord back in and turn on your TV.</li> </ul>
INlink does not work	<ul style="list-style-type: none"> <li>Make sure that the device you want to control is HDMI CEC-compatible.</li> <li>Make sure that the HDMI device's power cord is connected correctly.</li> <li>Make sure that the INlink Control option is set to <b>On</b> in the <i>INlink</i> menu. See "Using INlink" on page 38.</li> <li>Scan for INlink devices again. See "Using INlink" on page 38.</li> <li>Connect an INlink device using an HDMI 1.3 cable.</li> <li>If it the HDMI cable is disconnected then reconnected or if the power is turned off scan for INlink devices again. See "Using INlink" on page 38.</li> </ul>

## Specifications

Design specifications are subject to change without notice. Dimensions and weight specifications are approximate.

LCD panel	<b>NS-26L450A11:</b> 26-inch active matrix full high- definition TFT <b>NS-32L450A11:</b> 32-inch active matrix full high- definition TFT
Resolution	1920 × 1080 (RGB vertical stripe)
Color	8 bit / 1.07 B
Viewing angle	178° horizontal/178° vertical
Contrast ratio	2500:1
Brightness (typical)	450 nits
Response time	8.0 ms



Dimensions (W × D × H)	<b>NS-26L450A11:</b> With stand: 25.65 × 18.49 × 6.79 in (651.5 × 469.75 × 172.48 mm) Without stand: 25.65 × 16.92 × 3.45 in (651.5 × 429.65 × 87.6 mm)
	<b>NS-32L450A11:</b> With stand: 31.081 × 22.127 × 8.212 in (789.46 × 562.03 × 208.6 mm) Without stand: 31.081 × 20.324 × 3.637 in (789.46 × 516.23 × 92.4 mm)
Weight	<b>NS-26L450A11:</b> With stand: 15.2 lb (6.9 kg) Without stand: 14.25 lb (6.47 kg)
	<b>NS-32L450A11:</b> With stand: 21.759 lb (9.87 kg) Without stand: 18.849 lb (8.55 kg)
TV standard	NTSC, ATSC
Frequency range	VHF and UHF CATV 135 channel, QAM channels
Compatibility 480i	480P, 720P, 1080i, 1080P
USB	Compliance: USB 2.0 Device compatibility: USB flash drive
Input voltage	120 VAC, 60 Hz, 3A
Power consumption	<b>NS-26L450A11:</b> On: <60W Off: <1W
	<b>NS-32L450A11:</b> On: <78W Off: <1W
Speaker output	10 W (two channels)
Input/output jacks	Standard AV: CVBS video, audio L/R S-Video: S-Video, audio L/R Component: Y, PB, Pr, audio L/R HDMI 1–3: HDMI IN VGA and VGA/ DVI AUDIO IN: VGA and audio input Headphone: 3.5 mm audio Audio: Analog audio output and digital audio SPDIF output Antenna: F type
Image processor	Broadcom Xilleon™ 35143
Operating conditions	Temperature: 59°F ~ 95°F (15°C ~ 35°C) when humidity < 75% Humidity: 20 to 90% non-condensing (Ta < 35%)
Accessories	AC power cord TV stand Remote control with (2) AA batteries Remote control holder Screws for TV stand Component cable Audio cable TV base cover Cleaning cloth <i>Quick Setup Guide</i>

## Manufacturers' codes

### Audio amplifiers

Audio amplifiers	
Adcom	30577, 31100
Anthem	32220
Bose	30674
Carver	30892
Durabrand	31561
Elan	30647
GE	30078
Harman/Kardon	30892
JVC	30331
Left Coast	30892
Lenox	31561
Marantz	30892
McIntosh	30251
Modulaire	30395
NEC	30264
Optimus	30395, 30823
Philips	30892
Pioneer	30823
Polk Audio	30892
RadioShack	30395
RCA	30823
Realistic	30395
Shure	30264
Sony	30689, 30815
Soundesign	30078
Victor	30331
Wards	30078
Yamaha	30354, 30133

### Audio accessories

Audio accessories	
Accurian	31106
Altec Lansing	30607, 31056
Apple	31115
Creative	30872
DLO	31155
GPX	32113
Griffin	31891
iDeck	31106
iHome	32152
iLive	32113
Imerge	31491
iPort	31917
Klipsch	31339
Marantz	31491
Memorex	32119
Monitor Audio	31106
Motorola	31464
Omnifi	31605
Roku	31828
Sonance	31917
Yamaha	31809, 31810, 32021

## Audio receivers

Audio receivers	
ADC	30531
Adcom	30616
Aiwa	31405, 30189, 30121, 31089, 31388, 31641
Akai	30244, 31512
Alco	31390
AMC	31077
Amphion Media Works	31563
AMW	31563
Anam	31609, 31074
Anthem	31185
Apex Digital	31257, 31430, 31774
Arcam	31189
Audiotronic	31189
Audiovox	31390
B & K	30702, 30820, 30840
BK	30702
Bose	31229, 30639, 31253, 31629, 31841, 31933
Cairn	30189
Cambridge Soundworks	31370
Capetronic	30531
Carver	31189, 30189, 30121, 31089, 31289
Coby	31389
Curtis Mathes	30014
Daewoo	31250
Denon	31360, 30121, 31104, 31142, 31306, 32857
Emerson	30531
Fisher	31801
Garrard	30463
Grundig	30189
Harman/Kardon	30110, 30189, 30891, 31289, 31304, 31306, 32241
Hitachi	31273, 31801
iLive	32013
Inkel	30491
Insignia	31030, 31077, 31893, 32169, 32175
Integra	30135, 30842, 31298, 31320, 31805
iSymphony	32258
JBL	30110, 31306
JVC	31058, 30074, 31374, 31495, 31871, 32239
Kawasaki	31390
Kenwood	31313, 31570, 30077, 30186, 31027
KLH	31390, 31412, 31428
Koss	31366, 31497
Lexicon	31076
LG	31293, 32197
Linn	30189
Liquid Video	31497
Magnavox	31189, 31269, 30189, 30391, 30531, 31089, 31266, 31514
Marantz	31189, 31269, 30189, 30891, 31089, 31289
McIntosh	31289
Micromega	31189, 30189
Mitsubishi	31393
Musicmagic	31089
Myryad	31189
Nakamichi	31313, 30097, 31555
Norcent	31389

## Audio receivers

Nova	31389
Onkyo	30135, 30842, 31298, 31320, 31531, 31805, 31905
Optimus	31023, 30074, 30014, 30121, 30186, 30531, 31074
Oritron	31366, 31497
Outlaw	30391
Panasonic	31308, 31518, 30367, 31275, 31288, 31316, 31548, 31633, 31763, 31764
Philips	31189, 31269, 30189, 30391, 30891, 31089, 31266
Pioneer	31023, 30014, 30150, 30244, 30531, 30630, 31123, 31384, 31935
Polaroid	31508
Polk Audio	30189, 31289
Proscan	31254
RadioShack	31609
RCA	31023, 31609, 31254, 30531, 31074, 31123, 31390, 31511
Realistic	31609, 30121, 30186
Revox	30189
Rio	31869
Samsung	31295, 31304, 31500
Sangean	32165
Sansui	31189, 30189, 31089
Sanyo	31251, 31469, 31801
Sharp	30186, 31286
Sharper Image	31556
Sherwood	30491, 31077, 31653, 31905, 32169
Sherwood	Newcastle 32169
Sonic Blue	31869
Sonic Frontiers	31185
Sony	31058, 31441, 31258, 31759, 31622, 30474, 31158, 31406, 31558, 31658, 31758, 31822, 31858
Stereophonics	31023
Sunfire	31313
Teac	30463, 31074, 31390, 31528
Technics	31308, 31518, 31633
Thorens	31189
Toshiba	30135, 30842, 31123, 31788
Venturer	31390
Victor	30074
Wards	30189, 30014
XM	31406
Yamaha	31023, 30176, 30186, 30376, 31176, 31276, 31331, 31375, 31376, 31476, 31815, 32061
Zenith	30857, 31293

## Cable converters

### Cable converters

A-Mark	00008, 00144
ABC	00237, 00003, 00008
Accuphase	00003
Acorn	00237
Action	00237
Active	00237
ADB	02586
Americast	00899
Amino	01602, 01822

**Cable converters**

Archer	00237
BCC	00276
Bell South	00899
British Telecom	00003
Century	00008
Cisco	01877,00877,01982
Clearmaster	00883
ClearMax	00883
Cool Box	00883
Coolmax	00883
Digeo	01187, 02187
Director	00476
Fosgate	00276
GE	00144
General Instrument	00476,00810,00276,00003
Gibraltar	00003
GMI	00883
GoldStar	00144
Hamlin	00009,00273
Hitachi	00003,00008, 00009
i3 Micro	01602
Insight	00476,00810
Jerrold	00476,00810, 00276, 00003
Memorex	00000
Mitsubishi	00003
Motorola	01376,00476, 00810, 00276, 01187, 01106, 01982
Multitech	00883
Myrio	01602,01822
Nova Vision	00008
Novaplex	00008
Pace	01877,00877,00237,00008,01982
Panasonic	00000,00008,00144,00107,01982
Paragon	00000,00008, 00525
Penney	00000
Philips	01305,00317
Pioneer	01877,00877, 00144, 00533
Pulsar	00000
Quasar	00000
RadioShack	00883
RCA	01256
Regal	00276,00279,00273
Runco	00000
Samsung	00003,00144,01982
Scientific Atlanta	01877,00877,00477,00237,00003,00000,00008,01982
Sejin	01602
Sony	01006
Sprucer	00144
Starcom	00003
Supercable	00276
Supermax	00883
Thomson	01256

**Cable/PVR combos**
**Cable/PVR combos**

Americast	00899
Amino	01822
Cisco	01877, 01982
Digeo	01187, 02187
General Instrument	00810
Jerrold	00810
Motorola	01376, 00810, 01187, 01106, 01982
Myrio	01822
Pace	01877, 00237, 01982
Pioneer	01877
RCA	01256
Scientific Atlanta	01877, 01982
Sony	01006
Supercable	00276
Thomson	01256
Zenith	00899

**CD players**
**CD players**

Acoustic Research	30420
Aiwa	30157
Arcam	30157
Audio Research	30157
Burmester	30420
Caim	30157
California Audio Labs	30029
Cambridge Soundworks	30157
Carver	30157
Curtis Mathes	30032
Denon	30034
DKK	30000
DMX Electronics	30157
Fisher	30000
Garrard	30393,30420
Genexxa	30032
Grundig	30157
Hafler	30173
Harman/Kardon	30100,30157,30173
Hitachi	30032
Inkel	30157,30180
Integra	30101
JVC	30032,30072
Kenwood	30626,30000,30029,30028,30190
KLH	31318,31711
Krell	30157
Linn	30157
Magnavox	30157,30038,30274
Marantz	30626,30029,30157,30038,30180,30435
Matsui	30157
McIntosh	30256,30290,30660
MCS	30029
Memorex	30000, 30032,30420
Micromega	30157
Miro	30000
Mission	30157
Modulaire	30000,30032,30087,30180,30420
MTC	30420

CD players	
Myryad	30157
NSM	30157
Onkyo	31327,30101
Optimus	30000,30032,30087,30393,30420
Panasonic	30029,30388,30752
Parasound	30420
Penney	30029
Philips	30626,30157,30274
Pioneer	31062,30032,31087
Polk Audio	30157
Proceed	30420
Proton	30157
QED	30157
Quad	30157
Quasar	30029
RadioShack	30000,30032,30180,30420
RCA	31062, 30032,30053,30420
Realistic	30000,30032,30087,30180,30420
Revox	30157
Roksan	30435
Rotel	30157,30420
SAE	30157
Sansui	30000,30157
Sanyo	30000,30087
Sharp	30180
Sherwood	30180
Sonic Frontiers	30157
Sony	30490,30000,30100,31364,30185
Sugden	30157
Sylvania	30157
Symphonic	30180
TAG McLaren	30157
Tandy	30032
Tascam	30393,30420
Teac	30490,30180,30393,30420
Technics	30029
Thule Audio	30157
Victor	30072
Wards	30032,30157,30053,30087
Yamaha	30490,30036,31292
Yorx	30000

DVD players	
Arrgo	21023
Aspire Digital	21168, 21407
Astar	21489
Audiovox	20717, 20790, 21041, 21071, 21072, 21121, 21122
Axion	21071, 21072
B & K	20655, 20662
BBK	21224
Bel Canto Design	21571
Blaupunkt	20717
Blue Parade	20571
Blue Sky	20695
Bose	21895, 22023
Brandt	20651
Broksonic	20695, 20868
California Audio Labs	20490
Celestial	21020
Centrex	20672, 21004
Cinea	20831
CineVision	20876, 20833, 20869
Citizen	21003, 20695, 21277
Clairtone	20571
Coby	20778, 21077, 21086, 21107, 21177
Craig	20831
Creative	20503, 20539
Curtis Mathes	21087
CyberHome	20816, 20874, 21023, 21024, 21117, 21129, 21502, 21537
Cytron	20705
Daewoo	20784, 20705, 20770, 20833, 20869, 21169, 21172, 21234, 21242
Dansai	20770
Daytek	20872
Decca	20770
Denon	20490, 20634, 22258
Denver	20778
Desay	21407
DigitalMax	21738
Digitrex	20672
Disney	20675, 21270
DiViDo	20705
Dual	20675, 21068, 21085
Durabrand	21127
DVD2000	20521
Electrohome	21003
Emerson	20591, 20675, 20821, 21268
Enterprise	20591
Entivo	20503, 20539
Enzer	20770
ESA	20821, 21268
Firstline	20651
Fisher	20670
Funai	20675, 21268, 21334
Gateway	21073, 21077, 21158
GE	20522, 20815, 20717
Go Video	20573, 20744, 20717, 20715, 20741, 20783, 20833, 20869, 21044, 21075, 21099, 21158, 21304, 21730
Go Vision	21071, 21072

### DVD players

DVD players	
3D LAB	20503, 20539
Accurian	20675, 21072, 21416
Advent	21016
Afreey	20698
Aiwa	20641
Akai	20695, 20705, 20770, 20899, 21089
Alba	20672, 20717
Alco	20790
Allegro	20869
Amphion Media Works	20872
AMW	20872
Apex Digital	20533, 20672, 20717, 20755, 20794, 20796, 20797, 20830, 21004, 21020, 21056, 21061, 21100

DVD players	
GoldStar	20741, 20869
Goodmans	20790
Gradiente	20490, 20651
Greenhill	20717
Grundig	20539, 20705
Harman/Kardon	20582, 20702
Hello Kitty	20831
Hitachi	20573, 20664, 21247
Hiteker	20672
Humax	21500, 21588
iLo	21348
Initial	20717
Insignia	21268
Integra	20571, 20627, 21769
IRT	20783
JBL	20702
Jensen	21016
JMB	20695
JVC	20558, 20623, 20867, 21164, 21275, 21550
Kawasaki	20790
Kenwood	20490, 20534
KLH	20717, 20790, 21020, 21149
Kloss	20533
Koss	20651, 21061
Lasonic	20627, 20798
Lecson	21533
Lennox 21127	
LG	20591, 20741, 20869
LiteOn	21058, 21158, 21416, 21440, 21656, 21738
Loewe	20511, 20741
Logix	20783
Magnasonic	20651, 20675
Magnavox	20503, 20539, 20646, 20675, 20821, 21268, 21354, 21506
Marantz	20503, 20539, 20675
McIntosh	21533, 21273
Medion	20651
Memorex	20695, 20831, 21270
Microsoft	20522, 22083
Minato	20752
Mintek	20839, 20717
Mitsubishi	21521, 20521
NAD	20741
Naiko	20770
NEC	20785, 20869
Nesa	20717
NexxTech	21402
Norcent	21003, 20872, 21107, 21265
Onkyo	20503, 20627, 21769
Oppo	20575, 21224
Optimus	20571
Oritron	20651
Palsonic	20672
Panasonic	20503, 20490, 20571, 20632, 20703, 21362, 21462, 21490, 21641, 21762
Philco	20675
Philips	20503, 20539, 20646, 20675, 20854, 21260, 21267, 21340, 21354, 22056, 22084
PianoDisc	21024

DVD players	
Pioneer	20525, 20571, 20142, 20631, 20632, 21460, 21512, 21571
Polaroid	21020, 21061, 21086
Polk Audio	20539
Portland	20770
Presidian	20675, 21072, 21738
Prima	21016
Proceed	20672
Proscan	20522
ProVision	20778
Qwestar	20651
Radionette	20741
RadioShack	20571
RCA	20522, 20571, 20717, 20790, 20822, 21022, 21132, 21769
Realistic	20571
Reoc	20752
Rio	20869
Rotel	20623, 21178
Rowa	20823, 21004
Saba	20651
Sampo	20698, 20752
Samsung	20490, 20573, 20744, 20199, 20820, 20899, 21044, 21075
Sansui	20695
Sanyo	20670, 20675, 20695, 20873, 21334
Schneider	20783
Schwaiger	20752
Sensory Science	21158
Sharp	20630, 20675, 20752, 21256, 22250
Sharper Image	21117
Sherwood	20770, 21043, 21077
Sherwood Newcastle	21077
Shinsonic	20533, 20839
Slim Art	20784
Sonic Blue	20573, 20715, 20783, 20869, 21099
Sony	20533, 21533, 20864, 21033, 21070, 21431, 21516
Sova	21122
Superscan	20821
SVA	20717
Sylvania	20675, 20821, 21268
Symphonic	20675, 20821, 21268, 21334
Tatung	20770
Teac	20571, 20717, 20790
Technics	20490, 20703
Technika	20770
Terapin	21031
Tevion	20651
Theta Digital	20571
Thomson	20522, 20511
Tivo	21503, 21512, 21588
Toshiba	20503, 20573, 20539, 20695, 21045, 21154, 21503, 21510, 21588, 21769
Unimax	20770
Universum	20591
Urban Concepts	20503, 20539
US Logic	20839
V	21064, 21226

DVD players	
Venturer	20790
Vizio	21064, 21226
Xbox	20522, 22083
Yamaha	20490, 20539, 20545
Yamakawa	20872
Zenith	20503, 20591, 20741, 20869
Zeus	20784
Zoece	21265

**DVD players (Blu Ray and HD-DVD)**

DVD players (Blu Ray and HD-DVD)	
Denon	22258
Integra	21769
LG	20741
Microsoft	22083
Onkyo	21769
Panasonic	21641
Philips	22084
Pioneer	20142
RCA	21769
Samsung	20199
Sharp	22250
Sony	21516
Toshiba	21769
Xbox	22083

**DVD/PVR combos controlled by the DVD**

DVD/PVR combos controlled by the DVD	
Go Video	21730
Humax	21500, 21588
LG	20741
Panasonic	20490
Philips	21340
Pioneer	20631, 21512
RCA	20522
Sharp	21256
Sony	21033, 21070
Sylvania	20675
Tivo	21512
Toshiba	21503, 21510, 21588

**Home automation**

Home automation	
Accutek	31215
Amana	31716
Bionaire	30846, 31215, 31861
Da-Lite	31794
Draper	32190
Frigidaire	31333
GE	30240
GoldStar	31537
Holmes	31215
Kenmore	31537
Lasko	30846, 31890
LG	31537
Lightolier	30184
Lutron	30597, 30318, 31239, 31597
Marmitek	30167

Home automation	
One For All	30167
PCS	30184
RadioShack	30240
Screen Research	32097
Security System	30167
Sharper Image	30846
SmartLinc	30184
Universal	30167
Universal X10	30167
Whirlpool	31332
Windmere	31215
X10	30167

**DVR/PVR Systems for satellite receivers**

DVR/PVR systems for satellite receivers	
AlphaStar	00772
Bell ExpressVu	00775, 01170
Chaparral	00216
Coolsat	01806
Crossdigital	01109
DirecTV	01377, 00392, 00566, 00639, 01639, 01142, 00247, 00749, 01749, 00819, 01856, 01076, 01108, 00099, 01109, 01392, 01414, 01442, 01443, 01444, 01609, 01640
Dish Network System	01505, 00775, 01170, 01775
Dishpro	01505, 00775, 01775
Echostar	01505, 00775, 01170, 01775
Expressvu	00775, 01775
Fortec Star	01821
Funai	01377
GE	00392, 00566
General Instrument	00869
GOI	00775, 01775
Hitachi	00749, 00819
Houston	00775
HTS	00775, 01775
Hughes Network Systems	01142, 00749, 01749, 01442, 01443, 01444
Humax	01790
Innova	00099
Jerrold	00869
JVC	00775, 01170, 01775
LG	01226, 01414
Magnavox	00722
McIntosh	00869
Mitsubishi	00749
Motorola	00869
Netsat	00099
Next Level	00869
Panasonic	00247, 00701
Pansat	01807
Philips	01142, 00749, 01749, 00775, 00819, 01076, 00722, 00099, 01442
Primestar	00869
Proscan	00392, 00566
RadioShack	00566, 00775, 00869
RCA	00392, 00566, 01142, 00775, 00855, 00143, 01392, 01442
Samsung	01377, 01142, 01276, 01108, 01109, 01442, 01609

DVR/PVR systems for satellite receivers	
SKY	00099
Sony	00639, 01639, 01640
Star Choice	00869
Star Trak	00772, 00869
Thomson	00392, 00566
Tivo	01142, 01442, 01443, 01444
Toshiba	00749, 01749, 00790, 01285
UltimateTV	01392, 01640
Ultrasat	01806
Uniden	00722
Voom	00869
Zenith	01856

## TVs

TVs	
A-Mark	10047, 10054
Accurian	11803
Accuscan	10047
Action	10030, 10873
Admiral	10047, 10054, 10017, 10051, 10093, 10463, 10180
Advent	10761, 10783, 10815, 10817, 10842
Adventuri	10000
Agna	10150
Aiko	10092
Akai	10060, 10812, 10702, 10030, 10145, 10056, 10672, 11675, 11676, 11935
Albatron	10700, 10843
Alfide	10672
Alleron	10030
Ambassador	10150, 10177
America Action	10180
American High	10000, 10060
Ampro	10751
Amstrad	10171, 10177
Amtron	10000, 10180
Anam	10180
AOC	10180, 10030, 11365
Aomni	11623
Apex Digital	10156, 10748, 10879, 10765, 10767, 10890, 11217
Astar	11531, 11738
Audinac	10180
Audiovox	10451, 10180, 10092, 10623, 10802, 10846, 10875, 11937, 11951, 11952
Aventura	10171
Axion	11937
Baysonic	10180
Beaumarck	10017, 10178, 10030
Belcor	10030
Bell & Howell	10054, 10154, 10093
BenQ	11032, 11212, 11315
Boxlight	10893
Bradford	10180
Brockwood	10178, 10030, 10056
Broksonic	10236, 10463, 10180, 10177, 11935
Byd:sign	11309
Candle	10030, 10056
Capehart	10017, 10178, 10030, 10092

TVs	
Carnivale	10030
Carver	10054
Celebrity	10000
Celera	10765
Changhong	10156, 10765, 10767, 10783
Cineral	10451, 10092
Citek	10047
Citizen	10054, 10000, 10451, 10463, 10180, 10060, 10030, 10171, 10092, 10056, 11935
Clarion	10180
Classic	10030, 10092, 10056
Colortyme	10047, 10054, 10017, 10060, 10178, 10030
Commercial Solutions	11447, 10047
Concerto	10056
Conic	10178
Contec	10180
Craig	10180, 10171
Crosley	10054, 10000, 10180, 10030, 10171
Crown	10093, 10180, 10056, 10672
Crown Mustang	10672
Curtis Mathes	10047, 10054, 10154, 10000, 10051, 10451, 10093, 10180, 10060, 10702, 10178, 10030, 10145, 10166, 10056, 10466, 11147, 11347
CXC	10180
Cytron	11326
Daewoo	10451, 10178, 10092, 11661, 11756, 10623, 10661, 10672, 11755
Dayton	10092
Daytron	10178, 10030, 10092, 10056
Dell	11080, 11178, 11264, 11403, 11863
Denon	10145
Digital Life	10872
Dream Vision	11164
Dumont	10017, 10180, 10178
Durabrand	10463, 10180, 10178, 10171, 11034
Dwin	10093, 10720, 10774
Dynex	11463, 11780, 11785, 11810
Eaton	10060
Electroband	10000
Electrograph	11623, 11755
Electrohome	10154, 10000, 10463, 10150, 10178, 10030, 10056
Emerald	10178, 10177
Emerson	10047, 10154, 10451, 10236, 10463, 10180, 10150, 10178, 10171, 10177, 10623, 11394, 11963
Emprex	11422
Envision	10030, 10813, 11365
Epson	10833, 10840
ESA	10812, 10171, 11963
Fisher	10054, 10154, 10000
Fortress	10093
Fujitsu	10683, 10809, 10853
Funai	10000, 10180, 10171, 11271, 11963
Futuretech	10180
Gateway	11756, 11755
GE	11447, 10047, 10000, 10051, 10451, 10060, 10178, 10030, 11147, 11347
Gemini	10047
Gibraltar	10017, 10000, 10030

TVs	
Go Video	10886
Go Vision	11937
GoldStar	10047, 10054, 10178, 10030, 10056, 11154
Gradiente	10053, 10056
Grundig	10706, 10672, 10683
Grundy	10180
Grunpy	10180
Haier	11034
Hallmark	10236, 10180, 10178
Hannsree	11348, 11351, 11745
Harley Davidson	10000, 10180, 10060, 10178, 10030
Harman/Kardon	10054
Harvard	10180
Havermy	10093
Heathkit	10017
Helios	10865
Hello Kitty	10451
Hewlett Packard	11494, 11502, 11642
Hisense	10748
Hitachi	10047, 10054, 10017, 10000, 10051, 11145, 10145, 10056, 11445, 11643
HP	11494, 11502, 11642
Hyundai	10849, 10865, 11219, 11294
iLo	11286, 11603, 11684, 11990
Ima	10236, 10180, 10178
Infinity	10054
InFocus	11164
Initial	11603, 11990
Insignia	10171, 11204, 11326, 11517, 11564, 11641, 11710, 11780, 11963, 12002
Inteq	10017, 10145
JBL	10054
JCB	10000
Jensen	10761, 10815, 10817
JIL	10030
Jutan	10030
JVC	10054, 10053, 10030, 10650, 10731, 11253, 11774
Kamp	10017, 10180
Kawasho	10030
KEC	10180, 10060
Kenwood	10180, 10030
KLH	10156, 10180, 10765, 10767
Kloss	10030
Konka	10180, 10720
KTV	10463, 10180, 10030
Lark	10154
LG	10054, 11265, 10060, 10178, 10030, 10056, 10700, 10856, 11154, 11178, 11423, 11993
Lloyd's	10236, 10180, 10030, 10056
Logik	10236, 10180, 10056
Luxman	10056
LXI	10047, 10054, 10017, 10154, 10000, 10156, 10051, 10093, 10060, 10053, 10178, 10030, 10171, 10166, 10056
Magnasonic	10054, 10000, 10156, 10093, 10030, 10092, 10056
Magnavox	10047, 11454, 10054, 10154, 10000, 10250, 10051, 10180, 10060, 10030, 10171, 10092, 10706, 10802, 11198, 11254, 11365, 11755, 11866, 11963, 11990

TVs	
Majestic	10017
Marantz	11454, 10054, 10030, 10704, 10855, 11154, 11398
Matsui	10056, 10177
Matsushita	10250, 10051, 10650
Maxent	11756, 10762, 11211, 11714, 11755, 11757
Megapower	10700
Megatron	10047, 10178, 10145, 10056
Memorex	10154, 10463, 10180, 10150, 10178, 10030, 10056
MGA	10150, 10178, 10030
MGN Technology	10178
Micro Genius	10150
Midland	10047, 10017, 10051, 10056
Mintek	11603, 11990
Mitsubishi	10154, 10093, 11250, 10150, 10178, 10030, 10836, 10868, 11392
Monivision	10700, 10843
Motorola	10054, 10051, 10093, 10150
MTC	10180, 10060, 10030, 10092, 10056
Multitech	10180
NAD	10156, 10178, 10166, 10056, 10866, 11156
NEC	10047, 10178, 10030, 10056, 10497, 10704, 10882, 11398, 11704
NetTV	10762, 11755
New Tech	10056
Nikko	10178, 10030, 10092
Nikkodo	10178, 10030, 10092
Nishi	10030
Norcent	10748, 10824, 11365
Norwood Micro	11286
NTC	10092
Nyon	10000
Olevia	11144, 11240, 11331, 11610
Onwa	10180
Optimus	10154, 10250, 10093, 10180, 10150, 10178, 10030, 10166, 10056, 10650
Optoma	11348
Optonica	10093
Orion	10017, 10236, 10463, 10180, 10178, 11463, 10177
Pace	10092
Panasonic	10054, 10000, 10156, 10250, 10051, 10236, 10030, 10650, 11291, 11310, 11410, 11480, 11941
Panda	10706
Paxonic	10060, 10030
PCE	10156, 10060
Penney	10047, 10000, 10156, 10250, 10051, 10060, 10178, 10030, 10056, 11347
Petters	11523
Philco	10054, 10463, 10030, 10145
Philips	11454, 10054, 10030, 10171, 10056, 10690, 11154, 11254, 11744, 11867
Pilot	10051, 10060, 10178, 10030, 10056
Pioneer	10166, 10679, 10866, 11260, 11398, 11457
Planar	11496
Polaroid	10765, 10865, 11276, 11314, 11326, 11328, 11341, 11523, 11766, 12002
Portland	10451, 10092
Precision	10236, 10180, 10177



TVs	
Prima	10761, 10783, 10815, 10817, 11785
Princeton	10700, 10717
Prism	10250, 10051
Proscan	11447, 10047, 10466, 11347
Proton	10178, 10466
Pulsar	10017, 10092
Pulser	10178, 10092
Quartz	10150, 10178
Quasar	10250, 10051, 10650
Rabbit	10047
RadioShack	10047, 10154, 10180, 10150, 10178, 10030, 10056
RCA	11447, 10047, 10054, 10000, 10051, 10093, 10178, 12002, 11958, 11781, 11547, 11347, 11247, 11147, 11047, 10774, 10679, 10090
Realistic	10047, 10154, 10180, 10150, 10178, 10030, 10056
RevolutionHD	11623
Runco	10017, 10060, 10030, 10497, 10603, 11292, 11398, 11629
Sampo	10047, 10030, 11756, 10762, 11755
Samsung	10047, 10054, 10017, 10154, 10060, 10812, 10702, 10178, 10030, 10056, 10587, 10766, 10814, 11060, 11575
Sanky	10060, 10030
Sansui	10463, 10060, 10030, 11409, 11935
Sanyo	10047, 10054, 10154, 10000, 10463, 10171, 10088, 10799, 10893, 11142, 11755
Saville	10060
Sceptre	10878, 11217, 11360, 11599
Scotch	10178
Scott	10236, 10180, 10178, 10030, 10177, 11711
Sears	10047, 10054, 10017, 10154, 10000, 10156, 10051, 10093, 10060, 10053, 10178, 10030, 10171, 10166, 10056
Seleco	11351
Sharp	10054, 10093, 10180, 10491, 10688, 10689, 10818, 10851, 11602
Sheng Chia	10093
Shivaki	10178
Siemens	10145
Signature	10047, 10093, 10030
Simpson	10178, 10030
Singer	10060, 10092
Solar Drape	10000
Sole	10813, 11623
Sony	10017, 10154, 11100, 10000, 10150, 10053, 10834, 11685
Soundesign	10180, 10178, 10056
Sova	11952
Soyo	11520, 11826
Spectravision	10156, 10178
Squareview	10171
SR2000	10154, 10171
SSS	10180
Starlite	10236, 10180
Studio Experience	10843
Superscan	10093, 10864
Supreme	10000
SV2000	10054
SVA	10748, 10587, 10865, 10870, 10871, 10872

TVs	
Sylvania	10047, 10054, 10154, 10000, 10051, 10178, 10030, 10171, 10092, 10056, 11271, 11314, 11394, 11864, 11963
Symphonic	10000, 10180, 10178, 10171
Syntax	11144, 11240, 11331, 11610
Tandy	10093
Tatung	10000, 10051, 11756, 11286
Teac	10154, 10706, 10689
Technics	10054, 10250, 10051
Technovox	10030
Techview	10847, 12004
Techwood	10250, 10051, 10060, 10056
Teco	11040
Teknika	10054, 10463, 10180, 10150, 10060, 10178, 10092, 10056
Telecolor	10017
Telefunken	10702, 10056
Thomas	10047, 10178, 10056
Thomson	11447, 10047
TMK	10236, 10180, 10178, 10056, 10177
TNCi	10017
Tocom	10156
Toshiba	10154, 11256, 10156, 10150, 11265, 10060, 11145, 10145, 10166, 12006, 11935, 11704, 11656, 11635, 11524, 11356, 11164, 11156, 10845, 10832, 10822, 10650
Totevision	10051
Toyomenka	10178
Truetone	10250, 10051
TruTech	11723
TVS	10463
Ultra	10092
Universal	10047
Universum	10177
US Logic	11286
V	11756, 10864, 10885, 11755
Vector Research	10030
Victor	10053
Vidikron	10054, 11292, 11398, 11629
Vidtech	10178
Viewsonic	10857, 10864, 10885, 11330, 11578, 11627, 11640, 11755, 12014
Viking	10060
Viore	11684
Vizio	11756, 11758, 10864, 10885, 11755
Wards	10047, 10054, 10017, 10154, 10000, 10051, 10093, 10236, 10178, 10030, 10166, 10056, 10866, 11156
Waycon	10156
Welton	10178
Westinghouse	10000, 10451, 10885, 10889, 10890, 11282, 11577, 11712
White Westinghouse	10451, 10236, 10463, 10623, 10889
World	10451, 10236, 10463, 10180
Wyse	11365
XR-1000	10154, 10180, 10171
Yamaha	10030, 10769, 10833, 10839, 11526
Yorx	10030
Zenith	10047, 10017, 10000, 10093, 10463, 11265, 10812, 10178, 10030, 11145, 10145, 10171, 10092

### TV/DVD combination controlled by the DVD

TV/DVD combination controlled by the DVD	
Advent	21016
Akai	20695
Apex Digital	20830
Audiovox	21071, 21121, 21122
Axion	21071
Broksonic	20695
Citizen	20695
Emerson	20675, 21268
ESA	21268
Funai	21268
Go Vision	21071
Hitachi	21247
Insignia	21268
Jensen	21016
Magnavox	21268
Panasonic	21490
Philips	20854, 21260
Prima	21016
RCA	21022
Samsung	20899
Sansui	20695
Sova	21122
Sylvania	20675, 21268
Toshiba	20695

### TV/DVD combination controlled by the TV

TV/DVD combination controlled by the TV	
Accurian	11803
Akai	11675, 11935
Audiovox	11937, 11951, 11952
Axion	11937
Broksonic	11935
Citizen	11935
Dynex	11810
Emerson	11394, 11963
ESA	11963
Funai	11963
iLo	11990
Initial	11990
Insignia	11963, 12002
LG	11993
Magnavox	11866, 11963, 11990
Maxent	11714
Mintek	11990
Panasonic	11941
Polaroid	11523, 11766, 12002
RCA	11958, 12002
Sansui	11935
Sova	11952
Sylvania	11394, 11864, 11963
Techview	12004
Toshiba	11524, 11635, 11935, 12006

### TV/VCR combination controlled by the TV

TV/VCR combination controlled by the TV	
America Action	10180
Audiovox	10180
Emerson	10236

### TV/VCR combination controlled by the VCR

TV/VCR combination controlled by the VCR	
Broksonic	20479, 21479
Citizen	21278
Curtis Mathes	21035
Daewoo	21278
Emerson	20479, 20593, 21278, 21479
Funai	20000
GE	20807, 21035, 21060
GoldStar	21237
Harley Davidson	20000
Hitachi	20000
LG	21037
Lloyd's	20000
Magnasonic	20593, 21278
Magnavox	20000, 20593, 21781
Memorex	20162, 21037, 21162, 21237, 21262
Mitsubishi	20807
Optimus	20162, 20593, 21162, 21262
Orion	20479, 21479
Panasonic	20162, 21035, 21162, 21262
Penney	21035, 21237
Quasar	20162, 21035, 21162
RadioShack	20000, 21037
RCA	20807, 21035, 21060
Samsung	21014
Sansui	20000, 20479, 21479
Sears	20000, 21237
Sony	20000, 21232
Sylvania	21781
Symphonic	20000, 20593
Thomas	20000
Toshiba	20845, 21145
Zenith	20000, 20479, 21479

### TV/VCR/DVD combination controlled by the DVD

TV/VCR/DVD combination controlled by the DVD	
Akai	20899
Broksonic	20868
Emerson	20821
ESA	20821
Funai	21334
Magnavox	20821
Panasonic	21362, 21462
RCA	21132
Sharp	20630
Superscan	20821
Sylvania	20821
Symphonic	20821
Toshiba	21045

**TV/VCR/DVD combination controlled by the VCR**

TV/VCR/DVD combination controlled by the VCR	
Sharp	20807

**VCRs**

VCRs	
A-Mark	20037, 20000, 20046
ABS	21972
Accurian	20000
Admiral	20060, 20048, 20039, 20209, 20479
Adventura	20037, 20000
Aiwa	20037, 20000
Alba	20209
Alienware	21972
Allegro	20039
American High	20035, 20081
Amstrad	20000
Astra	20035
Audiovox	20037, 20038
Avis	20000
Bell & Howell	20035, 20048, 20039, 20000, 20046, 20479
Broksonic	20184, 20121, 20209, 20479, 21479
Calix	20037
Candle	20037, 20038
Canon	20035
Carver	20035, 20081
Citizen	20035, 20037, 20000, 20209, 20479, 21278
Classic	20037
Colortyme	20060, 20035, 20045
Colt	20000
Craig	20037
Criterion	20000
Crosley	20035, 20081, 20000, 20149
Curtis Mathes	20060, 20035, 20162, 20000, 21035
CyberPower	21972
Daewoo	20037, 20045, 20046, 21278
Daytron	20037
Dell	21972
Denon	20081, 20042
DirecTV	20739
Dual	20000
Durabrand	20039, 20038
Dynatech	20000
Electrohome	20060, 20037, 20000, 20043, 20209
Electroponic	20037
Emerald	20184, 20121
Emerex	20032
Emerson	20037, 20184, 20000, 20121, 20043, 20209, 20479, 20593, 21278, 21479, 21593
Fisher	20039, 20000, 20046
Fuji	20035, 20033
Fujitsu	20000
Funai	20037, 20000, 20593, 21593
Garrard	20000
Gateway	21972
GE	20060, 20035, 20048, 20000, 20149, 20807, 21035, 21060
Gemini	20060
Genexxa	20037, 20000

**VCRs**

Go Video	20614
GoldStar	20035, 20037, 20039, 20000, 20038, 21237
Goodmans	20037, 20081, 20000
Gradiente	20000
Granada	20081, 20042
Grundig	20081
Harley Davidson	20000
Harman/Kardon	20081, 20038
Headquarter	20046
Hewlett Packard	21972
HI-Q 20035,	20000
Hitachi	20035, 20037, 20045, 20000, 20042, 20089
Howard Computers	21972
HP	21972
Hughes Network Systems	20042, 20739
Humax	20739
Hush	21972
Hytek	20000
iBUYPOWER	21972
Instant Replay	20035
Jensen	20067
JVC	20067, 21162
KEC	20037
Kenwood	20067, 20038, 20046
Kodak	20035, 20037
KTV	20000
LG	20037, 20038, 21037
Linksys	21972
Lloyd's	20000, 20038
Loewe	20081
Logik	20000
Luxor	20046
LXI	20037, 20000, 20042, 20067
Magnasonic	20037, 20000, 20593, 21278
Magnavox	20035, 20037, 20048, 20039, 20081, 20000, 20149, 20563, 20593, 20618, 21593, 21781
Marantz	20035, 20081, 20038
Marta	20037
Matsui	20037, 20209
Matsushita	20035, 20162, 20081, 21162
Media Center PC	21972
MEI	20035
Memorex	20035, 20162, 20037, 20048, 20039, 20000, 20209, 20046, 20479, 21037, 21162, 21237, 21262
Metz	20037
MGA	20060, 20043
Microsoft	21972
Mind	21972
Minolta	20042
Mitsubishi	20060, 20048, 20000, 20042, 20067, 20043, 20807
Motorola	20035, 20048
MTC	20000
MTX	20000
Multitech	20039, 20000
NEC	20067, 20038
Nikko	20037

VCRs	
Nikkodo	20037
Niveus Media	21972
Northgate	21972
Olympus	20035, 20162
Optimus	21062, 20035, 20162, 20037, 20048, 20000, 20593, 21162, 21262
Orion	20184, 20000, 20121, 20209, 20479, 21479
Panama	20035
Panasonic	21062, 20035, 20162, 20000, 20225, 20614, 20616, 21035, 21162, 21262 Penney 20035, 20162, 20037, 20081, 20000, 20042, 20067, 20038, 21035, 21237
Pentax	20042
Philco	20035, 20081, 20000, 20209, 20479
Philips	20035, 20162, 20048, 20081, 20045, 20000, 20209, 20616, 20618, 20739, 21081, 21181
Pilot	20037
Pioneer	20162, 20081, 20042, 20067
Polk Audio	20081
Presidian	21593
Proscan	20060, 21060
Protec	20000
Pulsar	20039
Quarter	20046
Quartz	20035, 20046
Quasar	20035, 20162, 21035, 21162
RadioShack	20035, 20162, 20037, 20048, 20000, 20046, 21037, 21162
Radix	20037
Randex	20037
RCA	20060, 20035, 20048, 20045, 20000, 20042, 20149, 20807, 20880, 21035, 21060
Realistic	20035, 20162, 20037, 20048, 20000, 20121, 20046, 21162
ReplayTV	20614, 20616
Ricavision	21972
Runco	20039
Samsung	20060, 20045, 20000, 20038, 20739, 21014
Sanky	20048, 20039
Sansui	20000, 20067, 20209, 20479, 21479
Sanyo	20000, 20046, 20479
Scott	20184, 20045, 20121, 20043
Sears	20060, 20035, 20162, 20037, 20048, 20039, 20033, 20045, 20000, 20042, 20067, 20043, 20209, 20046, 21237
Sharp	20048, 20032, 20000, 20807, 20848
Shintom	20039, 20000
Siemens	20037
Signature	20060, 20035, 20037, 20048, 20000, 20149, 20046, 20479
Singer	20037
Sonic Blue	20614, 20616
Sonographe	20046
Sony	20035, 20032, 20033, 20000, 20067, 20046, 20636, 21032, 21232, 21972
Soundmaster	20000
Stack 9	21972
STS	20042
SV2000	20000
SVA	20000

VCRs	
Sylvania	20035, 20081, 20000, 20043, 20593, 21593, 21781
Symphonic	20000, 20593, 21593
Systemax	21972
Tagar Systems	21972
Tandy	20000
Tashiko	20037
Tatung	20048, 20081, 20000, 20067
Teac	20000, 20067
Technics	20035, 20162, 20037, 20000
Teknika	20035, 20037, 20000
Tevion	20479
Thomas	20000
Thomson	20060
Tivo	20618, 20636, 20739, 21996
TMK	20000
TNIX	20037
Toshiba	20045, 20000, 20043, 20209, 20845, 21008, 21145, 21972, 21996
Totevision	20037
Touch	21972
Trix	20037
Ultra	20045
Vector	20045
Vector Research	20184, 20038
Victor	20067
Video Concepts	20045
Videomagic	20037
Videosonic	20000
Viewsonic	21972
Villain	20000
Voodoo	21972
Wards	20060, 20035, 20037, 20048, 20081, 20033, 20045, 20000, 20042, 20043, 20038, 20149, 20046, 20479
Wharfedale	20593
White Westinghouse	20000, 20209, 20479
World	20209, 20479
XR-1000	20035, 20000
Yamaha	20038
Zenith	20037, 20039, 20033, 20000, 20209, 20479, 21479
ZT Group	21972

### Video Accessories

Video Accessories	
2Wire	02045
ABS	01272
Access HD	02185
Accurian	01653
Alienware	01272
Amino	01481
AT&T	00858, 02045
Buffalo	01739
CASTi	02305
CyberPower	01272
D-Link	01554, 01731, 02186
Digital Stream	02303
Epson	01563

Video Accessories	
Gateway	01272
Hewlett Packard	01272, 01267
Howard Computers	01272
HP	01272, 01267
Hush	01272
iBUYPOWER	01272
Insignia	01415
KoolConnect	01481
LG	01415
Linksys	01272, 01365
Media	Center PC 01272
Microsoft	01272, 02049
Mind	01272
Motorola	00858, 01363, 01998
Netgear	02036
Niveus Media	01272
Northgate	01272
Panasonic	01120
Pioneer	01010
Ricavision	01272
Roku	01486
Samsung	01190, 01490
Scientific Atlanta	00858
Sensory Science	01126
Sharp	01010
SMC	01456
Sony	01272, 01324, 01364
Stack 9	01272
SureWest	01481
Sylvania	01563
Systemax	01272
Tagar Systems	01272
Toshiba	01272
Touch	01272
Viewsonic	01272, 01329
Vizio	01126
Voodoo	01272
VUDU	02298
Xbox	02049
Zenith	01415
ZT Group	01272

## Legal notices

### FCC Part 15

This device complies with Part 15 of the FCC Rules. Operation of this product is subject to the following two conditions: (1) this device may not cause harmful interference, and (2) this device must accept any interference received, including interference that may cause undesired operation.

This equipment has been tested and found to comply within the limits for a class B digital device, pursuant to Part 15 of the FCC Rules. These limits are designed to provide reasonable protection against harmful interference in a residential installation. This equipment generates, uses, and can radiate radio frequency energy and, if not installed and used in accordance with the instructions, may cause harmful interference to radio communications. However, there is no guarantee that interference will not occur in a particular installation. If this equipment does cause harmful interference to radio or television reception, which can be determined by turning the equipment off and on, the user is encouraged to try to correct the interference by one or more of the following measures:

- Reorient or relocate the receiving antenna.
- Increase the separation between the equipment and receiver.
- Connect the equipment into an outlet on a circuit different from that to which the receiver is connected.
- Consult the dealer or an experienced radio/TV technician for help.

### FCC warning

Changes or modifications not expressly approved by the party responsible for compliance with the FCC Rules could void the user's authority to operate this equipment.

### DHHS and FDA safety certification

This product is made and tested to meet safety standards of the FCC, requirements and compliance with safety performance of the U.S. Department of Health and Human Services, and also with FDA Radiation Performance Standards 21 CFR Subchapter J.

### Canada ICES-003 statement

This Class B digital apparatus complies with Canadian ICES-003. Standard Television Receiving Apparatus — Appareil de réception télévision ordinaire, Canada BETS-7 / NTMR-7

### RSS 310 statement

To reduce potential radio interference to other users, the antenna type and its gain should be so chosen that the equivalent isotropically radiated power (e.i.r.p.) is not more than that permitted for successful communication.

### HDMI



HDMI, the HDMI logo, and High-Definition Multimedia Interface are trademarks or registered trademarks of HDMI Licensing LLC.

### Audyssey

Audyssey Dynamic Volume™



### Energy Star



To meet Energy Star requirements, keep TV settings at the factory default settings.

## SRS TruSurround HD



is a trademark of SRS Labs, Inc. TruSurround HD technology is incorporated under license from SRS Labs, Inc.

SRS TruSurround HD™ creates an immersive, feature-rich surround sound experience from two speakers, complete with rich bass, high frequency detail and clear dialog.

## PUBLIC LICENSE

This product contains software that is subject to the GNU Public License Version 2 (GPL2). You can obtain a copy of the GPL License from <http://www.gnu.org/licenses/old-licenses/gpl-2.0.html>.

If you require additional information or you wish to receive source code, please call the Insignia support line at 1-877-467-4289. The source code is available for a period of three (3) years from the date of the distribution of this product by Insignia.

## GNU PUBLIC LICENSE

The BD player runs software that is covered under the GPL. As such, we are required to publish the following:

GNU GENERAL PUBLIC LICENSE  
Version 2, June 1991

Copyright (C) 1989, 1991 Free Software Foundation, Inc.  
51 Franklin Street, Fifth Floor, Boston, MA 02110-1301, USA

Everyone is permitted to copy and distribute verbatim copies of this license document, but changing it is not allowed.

### Preamble

The licenses for most software are designed to take away your freedom to share and change it. By contrast, the GNU General Public License is intended to guarantee your freedom to share and change free software--to make sure the software is free for all its users. This General Public License applies to most of the Free Software Foundation's software and to any other program whose authors commit to using it. (Some other Free Software Foundation software is covered by the GNU Lesser General Public License instead.) You can apply it to your programs, too.

When we speak of free software, we are referring to freedom, not price. Our General Public Licenses are designed to make sure that you have the freedom to distribute copies of free software (and charge for this service if you wish), that you receive source code or can get it if you want it, that you can change the software or use pieces of it in new free programs; and that you know you can do these things.

To protect your rights, we need to make restrictions that forbid anyone to deny you these rights or to ask you to surrender the rights.

These restrictions translate to certain responsibilities for you if you distribute copies of the software, or if you modify it.

For example, if you distribute copies of such a program, whether gratis or for a fee, you must give the recipients all the rights that you have. You must make sure that they, too, receive or can get the source code. And you must show them these terms so they know their rights.

We protect your rights with two steps: (1) copyright the software, and (2) offer you this license which gives you legal permission to copy, distribute and/or modify the software.

Also, for each author's protection and ours, we want to make certain that everyone understands that there is no warranty for this free software. If the software is modified by someone else and passed on, we want its recipients to know that what they have is not the original, so that any problems introduced by others will not reflect on the original authors' reputations.

Finally, any free program is threatened constantly by software patents. We wish to avoid the danger that redistributors of a free program will individually obtain patent licenses, in effect making the program proprietary. To prevent this, we have made it clear that any patent must be licensed for everyone's free use or not licensed at all.

The precise terms and conditions for copying, distribution and modification follow.

## TERMS AND CONDITIONS FOR COPYING, DISTRIBUTION AND MODIFICATION

0. This License applies to any program or other work which contains a notice placed by the copyright holder saying it may be distributed under the terms of this General Public License. The "Program", below, refers to any such program or work, and a "work based on the Program" means either the Program or any derivative work under copyright law: that is to say, a work containing the Program or a portion of it, either verbatim or with modifications and/or translated into another language. (Hereinafter, translation is included without limitation in the term "modification".) Each licensee is addressed as "you".

Activities other than copying, distribution and modification are not covered by this License; they are outside its scope. The act of running the Program is not restricted, and the output from the Program is covered only if its contents constitute a work based on the Program (independent of having been made by running the Program). Whether that is true depends on what the Program does.

1. You may copy and distribute verbatim copies of the Program's source code as you receive it, in any medium, provided that you conspicuously and appropriately publish on each copy an appropriate copyright notice and disclaimer of warranty; keep intact all the notices that refer to this License and to the absence of any warranty; and give any other recipients of the Program a copy of this License along with the Program.

You may charge a fee for the physical act of transferring a copy, and you may at your option offer warranty protection in exchange for a fee.

2. You may modify your copy or copies of the Program or any portion of it, thus forming a work based on the Program, and copy and distribute such modifications or work under the terms of Section 1 above, provided that you also meet all of these conditions:

- You must cause the modified files to carry prominent notices stating that you changed the files and the date of any change.
- You must cause any work that you distribute or publish, that in whole or in part contains or is derived from the Program or any part thereof, to be licensed as a whole at no charge to all third parties under the terms of this License.
- If the modified program normally reads commands interactively when run, you must cause it, when started running for such interactive use in the most ordinary way, to print or display an announcement including an appropriate copyright notice and a notice that there is no warranty (or else, saying that you provide a warranty) and that users may redistribute the program under these conditions, and telling the user how to view a copy of this License. (Exception: if the Program itself is interactive but does not normally print such an announcement, your work based on the Program is not required to print an announcement.) These requirements apply to the modified work as a whole. If identifiable sections of that work are not derived from the Program, and can be reasonably considered independent and separate works in themselves, then this License, and its terms, do not apply to those sections when you distribute them as separate works. But when you distribute the same sections as part of a whole which is a work based on the Program, the distribution of the whole must be on the terms of this License, whose permissions for other licensees extend to the entire whole, and thus to each and every part regardless of who wrote it.

Thus, it is not the intent of this section to claim rights or contest your rights to work written entirely by you; rather, the intent is to exercise the right to control the distribution of derivative or collective works based on the Program.

In addition, mere aggregation of another work not based on the Program with the Program (or with a work based on the Program) on a volume of a storage or distribution medium does not bring the other work under the scope of this License.

3. You may copy and distribute the Program (or a work based on it, under Section 2) in object code or executable form under the terms of Sections 1 and 2 above provided that you also do one of the following:

- Accompany it with the complete corresponding machine-readable source code, which must be distributed under the terms of Sections 1 and 2 above on a medium customarily used for software interchange; or,
- Accompany it with a written offer, valid for at least three years, to give any third party, for a charge no more than your cost of physically performing source distribution, a complete machine-readable copy of the corresponding source code, to be distributed under the terms of Sections 1 and 2 above on a medium customarily used for software interchange; or,

c) Accompany it with the information you received as to the offer to distribute corresponding source code. (This alternative is allowed only for noncommercial distribution and only if you received the program in object code or executable form with such an offer, in accord with Subsection b above.)

The source code for a work means the preferred form of the work for making modifications to it. For an executable work, complete source code means all the source code for all modules it contains, plus any associated interface definition files, plus the scripts used to control compilation and installation of the executable. However, as a special exception, the source code distributed need not include anything that is normally distributed (in either source or binary form) with the major components (compiler, kernel, and so on) of the operating system on which the executable runs, unless that component itself accompanies the executable.

If distribution of executable or object code is made by offering access to copy from a designated place, then offering equivalent access to copy the source code from the same place counts as distribution of the source code, even though third parties are not compelled to copy the source along with the object code.

4. You may not copy, modify, sublicense, or distribute the Program except as expressly provided under this License. Any attempt otherwise to copy, modify, sublicense or distribute the Program is void, and will automatically terminate your rights under this License. However, parties who have received copies, or rights, from you under this License will not have their licenses terminated so long as such parties remain in full compliance.

5. You are not required to accept this License, since you have not signed it. However, nothing else grants you permission to modify or distribute the Program or its derivative works. These actions are prohibited by law if you do not accept this License. Therefore, by modifying or distributing the Program (or any work based on the Program), you indicate your acceptance of this License to do so, and all its terms and conditions for copying, distributing or modifying the Program or works based on it.

6. Each time you redistribute the Program (or any work based on the Program), the recipient automatically receives a license from the original licensor to copy, distribute or modify the Program subject to these terms and conditions. You may not impose any further restrictions on the recipients' exercise of the rights granted herein. You are not responsible for enforcing compliance by third parties to this License.

7. If, as a consequence of a court judgment or allegation of patent infringement or for any other reason (not limited to patent issues),

conditions are imposed on you (whether by court order, agreement or otherwise) that contradict the conditions of this License, they do not excuse you from the conditions of this License. If you cannot distribute so as to satisfy simultaneously your obligations under this License and any other pertinent obligations, then as a consequence you may not distribute the Program at all. For example, if a patent license would not permit royalty-free redistribution of the Program by all those who receive copies directly or indirectly through you, then the only way you could satisfy both it and this License would be to refrain entirely from distribution of the Program.

If any portion of this section is held invalid or unenforceable under any particular circumstance, the balance of the section is intended to apply and the section as a whole is intended to apply in other circumstances.

It is not the purpose of this section to induce you to infringe any patents or other property right claims or to contest validity of any such claims; this section has the sole purpose of protecting the integrity of the free software distribution system, which is implemented by public license practices. Many people have made generous contributions to the wide range of software distributed through that system in reliance on consistent application of that system; it is up to the author/donor to decide if he or she is willing to distribute software through any other system and a licensee cannot impose that choice.

This section is intended to make thoroughly clear what is believed to be a consequence of the rest of this License.

8. If the distribution and/or use of the Program is restricted in certain countries either by patents or by copyrighted interfaces, the original copyright holder who places the Program under this License may add an explicit geographical distribution limitation excluding those countries, so that distribution is permitted only in or among countries not thus excluded. In such case, this License incorporates the limitation as if written in the body of this License.

9. The Free Software Foundation may publish revised and/or new versions of the General Public License from time to time. Such new versions will be similar in spirit to the present version, but may differ in detail to address new problems or concerns.

Each version is given a distinguishing version number. If the Program specifies a version number of this License which applies to it and "any later version", you have the option of following the terms and conditions either of that version or of any later version published by the Free Software Foundation. If the Program does not specify a version number of this License, you may choose any version ever published by the Free Software Foundation.

10. If you wish to incorporate parts of the Program into other free programs whose distribution conditions are different, write to the author to ask for permission. For software which is copyrighted by the Free Software Foundation, write to the Free Software Foundation; we sometimes make exceptions for this. Our decision will be guided by the two goals of preserving the free status of all derivatives of our free software and of promoting the sharing and reuse of software generally.

## NO WARRANTY

11. BECAUSE THE PROGRAM IS LICENSED FREE OF CHARGE, THERE IS NO WARRANTY FOR THE PROGRAM, TO THE EXTENT PERMITTED BY APPLICABLE LAW. EXCEPT WHEN OTHERWISE STATED IN WRITING THE COPYRIGHT HOLDERS AND/OR OTHER PARTIES PROVIDE THE PROGRAM "AS IS" WITHOUT WARRANTY OF ANY KIND, EITHER EXPRESSED OR IMPLIED, INCLUDING, BUT NOT LIMITED TO, THE IMPLIED WARRANTIES OF MERCHANTABILITY AND FITNESS FOR A PARTICULAR PURPOSE. THE ENTIRE RISK AS TO THE QUALITY AND PERFORMANCE OF THE PROGRAM IS WITH YOU. SHOULD THE PROGRAM PROVE DEFECTIVE, YOU ASSUME THE COST OF ALL NECESSARY SERVICING, REPAIR OR CORRECTION.

12. IN NO EVENT UNLESS REQUIRED BY APPLICABLE LAW OR AGREED TO IN WRITING WILL ANY COPYRIGHT HOLDER, OR ANY OTHER PARTY WHO MAY MODIFY AND/OR REDISTRIBUTE THE PROGRAM AS PERMITTED ABOVE, BE LIABLE TO YOU FOR DAMAGES, INCLUDING ANY GENERAL, SPECIAL, INCIDENTAL OR CONSEQUENTIAL DAMAGES ARISING OUT OF THE USE OR INABILITY TO USE THE PROGRAM (INCLUDING BUT NOT LIMITED TO LOSS OF DATA OR DATA BEING RENDERED INACCURATE OR LOSSES SUSTAINED BY YOU OR THIRD PARTIES OR A FAILURE OF THE PROGRAM TO OPERATE WITH ANY OTHER PROGRAMS), EVEN IF SUCH HOLDER OR OTHER PARTY HAS BEEN ADVISED OF THE POSSIBILITY OF SUCH DAMAGES.

END OF TERMS AND CONDITIONS





## Two-year limited warranty

### US and Canada Markets

#### Definitions:

Insignia Products ("Insignia") warrants to you, the original purchaser of this new Insignia-branded television ("Product"), that the Product shall be free of defects in the original manufacturer of the material or workmanship for a period of two (2) years from the date of your purchase of the Product ("Warranty Period"). For this warranty to apply, your Product must be purchased in the United States or Canada from a Best Buy or Future Shop authorized dealer of Insignia brand products only that are packaged with this warranty statement.

#### How long does the coverage last?

The Warranty Period lasts for 2 years (730 days) from the date you purchased the Product. Your purchase date is printed on the receipt you received with the Product.

#### What does this warranty cover?

During the Warranty Period, if the original manufacture of the material or workmanship of the Product is determined to be defective by an authorized Insignia repair center or store personnel, Insignia will (at its sole option): (1) repair the Product with new or rebuilt parts; or (2) replace the Product at no charge with new or rebuilt comparable products or parts. Products and parts replaced under this warranty become the property of Insignia and are not returned to you. If service of Products or parts are required after the Warranty Period expires, you must pay all labor and parts charges. This warranty lasts as long as you own your Insignia Product during the Warranty Period. Warranty coverage terminates if you sell or otherwise transfer the Product.

#### How to obtain warranty service?

If you purchased the Product at a Best Buy or Future Shop retail store location and your television Product has a screen size of less than 37 inches, please take your original receipt and the Product to any Best Buy or Future Shop store. Make sure that you place the Product in its original packaging or packaging that provides the same amount of protection as the original packaging. If you purchased the Product from a Best Buy or Future Shop online web site, mail your original receipt and the Product to the address listed on the web site. Make sure that you put the Product in its original packaging or packaging that provides the same amount of protection as the original packaging.

To obtain in-home warranty service for a television with a screen 37 inches or larger, in the United States call 1-888-BESTBUY, Canada call 1-866-BESTBUY for Future Shop call 1-800-663-2275. Call agents will diagnose and correct the issue over the phone or will have an Insignia-approved repair technician dispatched to your home.

#### Where is the warranty valid?

This warranty is valid only to the original purchaser of the product in the United States and Canada at Best Buy or Future Shop branded retail stores or websites.

#### What does the warranty not cover?

This warranty does not cover:

- Customer instruction/education
- Installation
- Set up adjustments
- Cosmetic damage
- Damage due to acts of God, such as power surges
- Accident(s)
- Misuse
- Abuse
- Negligence
- Commercial purposes/use, including but not limited to use in a place of business or in communal areas of a multiple dwelling condominium or apartment complex, or otherwise used in a place of other than a private home.
- Modification of any part of the Product, including the antenna
- Plasma display panel damaged by static (non-moving) images applied for lengthy periods (burn-in).
- Damage due to incorrect operation or maintenance
- Connection to an incorrect voltage or power supply
- Attempted repair by any person not authorized by Insignia to service the Product

- Products sold "as is" or "with all faults"
- Consumables, including but not limited to batteries (i.e. AA, AAA, C etc.)
- Products where the factory applied serial number has been altered or removed
- Loss or Theft of this product or any part of the product

REPAIR REPLACEMENT AS PROVIDED UNDER THIS WARRANTY IS YOUR EXCLUSIVE REMEDY FOR BREACH OF WARRANTY. INSIGNIA SHALL NOT BE LIABLE FOR ANY INCIDENTAL OR CONSEQUENTIAL DAMAGES FOR THE BREACH OF ANY EXPRESS OR IMPLIED WARRANTY ON THIS PRODUCT, INCLUDING, BUT NOT LIMITED TO, LOST DATA, LOSS OF USE OF YOUR PRODUCT, LOST BUSINESS OR LOST PROFITS. INSIGNIA PRODUCTS MAKES NO OTHER EXPRESS WARRANTIES WITH RESPECT TO THE PRODUCT, ALL EXPRESS AND IMPLIED WARRANTIES FOR THE PRODUCT, INCLUDING, BUT NOT LIMITED TO, ANY IMPLIED WARRANTIES OF AND CONDITIONS OF MERCHANTABILITY AND FITNESS FOR A PARTICULAR PURPOSE, ARE LIMITED IN DURATION TO THE WARRANTY PERIOD SET FORTH ABOVE AND NO WARRANTIES, WHETHER EXPRESS OR IMPLIED, WILL APPLY AFTER THE WARRANTY PERIOD. SOME STATES, PROVINCES AND JURISDICTIONS DO NOT ALLOW LIMITATIONS ON HOW LONG AN IMPLIED WARRANTY LASTS, SO THE ABOVE LIMITATION MAY NOT APPLY TO YOU. THIS WARRANTY GIVES YOU SPECIFIC LEGAL RIGHTS, AND YOU MAY ALSO HAVE OTHER RIGHTS, WHICH VARY FROM STATE TO STATE OR PROVINCE TO PROVINCE.

Contact Insignia:

For customer service please call 1-877-467-4289

[www.insigniaproducts.com](http://www.insigniaproducts.com)

Distributed by Best Buy Purchasing, LLC

7601 Penn Avenue South, Richfield, Minnesota, U.S.A.

55423-3645

© 2010 BBY Solutions, Inc.

All rights reserved. INSIGNIA is a trademark of BBY Solutions, Inc. Registered in some countries. All other products and brand names are trademarks of their respective owners.

### Mexico Market

PLACE STICKER OF PRODUCT MAKE & MODEL HERE

DATE OF PURCHASE: \_\_\_\_\_

#### Definitions:

Insignia Products ("Insignia") warrants to you, the original purchaser of this new Insignia-branded television ("Product"), that the Product shall be free of defects in the original manufacturer of the material or workmanship for a period of two (2) years from the date of your purchase of the Product ("Warranty Period"). For this warranty to apply, your Product must be purchased in Mexico from a Best Buy authorized dealer of Insignia brand products only that are packaged with this warranty statement.

#### How long does the coverage last?

The Warranty Period lasts for 2 years (730 days) from the date you purchased the Product. Your purchase date is printed on the receipt you received with the Product.

What does this warranty cover?

During the Warranty Period, if the original manufacture of the material or workmanship of the Product is determined to be defective by an authorized Insignia repair center or store personnel, Insignia will (at its sole option): (1) repair the Product with new or rebuilt parts; or (2) replace the Product at no charge with new or rebuilt comparable products or parts. Products and parts replaced under this warranty become the property of Insignia and are not returned to you. and parts charges. This warranty lasts as long as you own your Insignia Product during the Warranty Period. Warranty coverage terminates if you sell or otherwise transfer the Product.

### How to obtain warranty service?

If you purchased the Product at a Best Buy retail store location and your television Product has a screen size of less than 37 inches, please take your original receipt and the Product to any Best store. Make sure that you place the Product in its original packaging or packaging that provides the same amount of protection as the original packaging. If you purchased the Product from a Best Buy a online web site, mail your original receipt and the Product to the address listed on the web site. Make sure that you put the Product in its original packaging or packaging that provides the same amount of protection as the original packaging.

To obtain in-home warranty service for a television with a screen 37 inches or larger, in Mexico call 01 800-433-5778. Call agents will diagnose and correct the issue over the phone or will have an Insignia-approved repair technician dispatched to your home.

### Where is the warranty valid?

This warranty is valid only to the original purchaser of the product in Mexico at a Best Buy branded retail store or website.

### What does the warranty not cover?

This warranty does not cover:

- Customer instruction/education
- Installation
- Set up adjustments
- Cosmetic damage
- Damage due to acts of God, such as power surges
- Accident(s)
- Misuse
- Abuse
- Negligence
- Commercial purposes/use, including but not limited to use in a place of business or in communal areas of a multiple dwelling condominium or apartment complex, or otherwise used in a place of other than a private home.
- Modification of any part of the Product, including the antenna
- Plasma display panel damaged by static (non-moving) images applied for lengthy periods (burn-in).
- Damage due to incorrect operation or maintenance
- Connection to an incorrect voltage or power supply
- Attempted repair by any person not authorized by Insignia to service the Product
- Products sold "as is" or "with all faults"

- Consumables, including but not limited to batteries (i.e. AA, AAA, C etc.)
- Products where the factory applied serial number has been altered or removed
- Loss or Theft of this product or any part of the product

REPAIR REPLACEMENT AS PROVIDED UNDER THIS WARRANTY IS YOUR EXCLUSIVE REMEDY FOR BREACH OF WARRANTY. INSIGNIA SHALL NOT BE LIABLE FOR ANY INCIDENTAL OR CONSEQUENTIAL DAMAGES FOR THE BREACH OF ANY EXPRESS OR IMPLIED WARRANTY ON THIS PRODUCT, INCLUDING, BUT NOT LIMITED TO, LOST DATA, LOSS OF USE OF YOUR PRODUCT, LOST BUSINESS OR LOST PROFITS. INSIGNIA PRODUCTS MAKES NO OTHER EXPRESS WARRANTIES WITH RESPECT TO THE PRODUCT, ALL EXPRESS AND IMPLIED WARRANTIES FOR THE PRODUCT, INCLUDING, BUT NOT LIMITED TO, ANY IMPLIED WARRANTIES OF AND CONDITIONS OF MERCHANTABILITY AND FITNESS FOR A PARTICULAR PURPOSE, ARE LIMITED IN DURATION TO THE WARRANTY PERIOD SET FORTH ABOVE AND NO WARRANTIES, WHETHER EXPRESS OR IMPLIED, WILL APPLY AFTER THE WARRANTY PERIOD. SOME STATES, PROVINCES AND JURISDICTIONS DO NOT ALLOW LIMITATIONS ON HOW LONG AN IMPLIED WARRANTY LASTS, SO THE ABOVE LIMITATION MAY NOT APPLY TO YOU. THIS WARRANTY GIVES YOU SPECIFIC LEGAL RIGHTS, AND YOU MAY ALSO HAVE OTHER RIGHTS, WHICH VARY FROM STATE TO STATE OR PROVINCE TO PROVINCE.

Contact Insignia:

For customer service please call 1-800-926-3000

[www.insigniaproducts.com](http://www.insigniaproducts.com)

Distributed by Best Buy Purchasing, LLC

7601 Penn Avenue South, Richfield, Minnesota, U.S.A.  
55423-3645

© 2010 BBY Solutions, Inc.

All rights reserved. INSIGNIA is a trademark of BBY Solutions, Inc. Registered in some countries. All other products and brand names are trademarks of their respective owners.

Mexico Retailer Address:

Best Buy Mundo E

Boulevard Manuel Avila Camacho 1007

Periferico Norte Santa Monica

Col. San Lucas Tepetlaco



# INSIGNIA™

If the power cord has been damaged, it should be replaced by the manufacturer, your service provider or qualified personnel to avoid risks.

Si el cordón de alimentación es dañado, este debe ser remplazado por el fabricante o su agente de servicio o por personal calificado para evitar el riesgo.

[www.insigniaproducts.com](http://www.insigniaproducts.com)  
US & Canada: 1 (877) 467-4289  
Mexico: 01 (800) 926 - 3000

Distributed by Best Buy Purchasing, LLC  
7601 Penn Avenue South, Richfield, MN USA 55423-3645

© 2010 BBY Solutions, Inc.

All rights reserved. INSIGNIA is a trademark of BBY Solutions, Inc. Registered in some countries.

All other products and brand names are trademarks of their respective owners.

Best Buy Imports, S. de R.L. de C.V. Av. Santa Fe 485, Segundo Piso, Colonia Cruz Manca, Programa Parcial de Desarrollo Santa Fe, Delegación Cuajimalpa, Distrito Federal, México 05349 RFC#BBI0802114Q2

Se incluye el manual. Favor de leer este manual antes de usar el producto.

Para el Soporte técnico de Insignia en México, favor llame al: <http://www.insigniaproducts.com>

ENGLISH  
10-0340

